

ZONE WIRELESS 2 ES FOR BUSINESS (WITH RECEIVER VERSION)

Setup Guide
设置指南



CONTENTS

English 3

简体中文 15

KNOW YOUR PRODUCT

FRONT VIEW

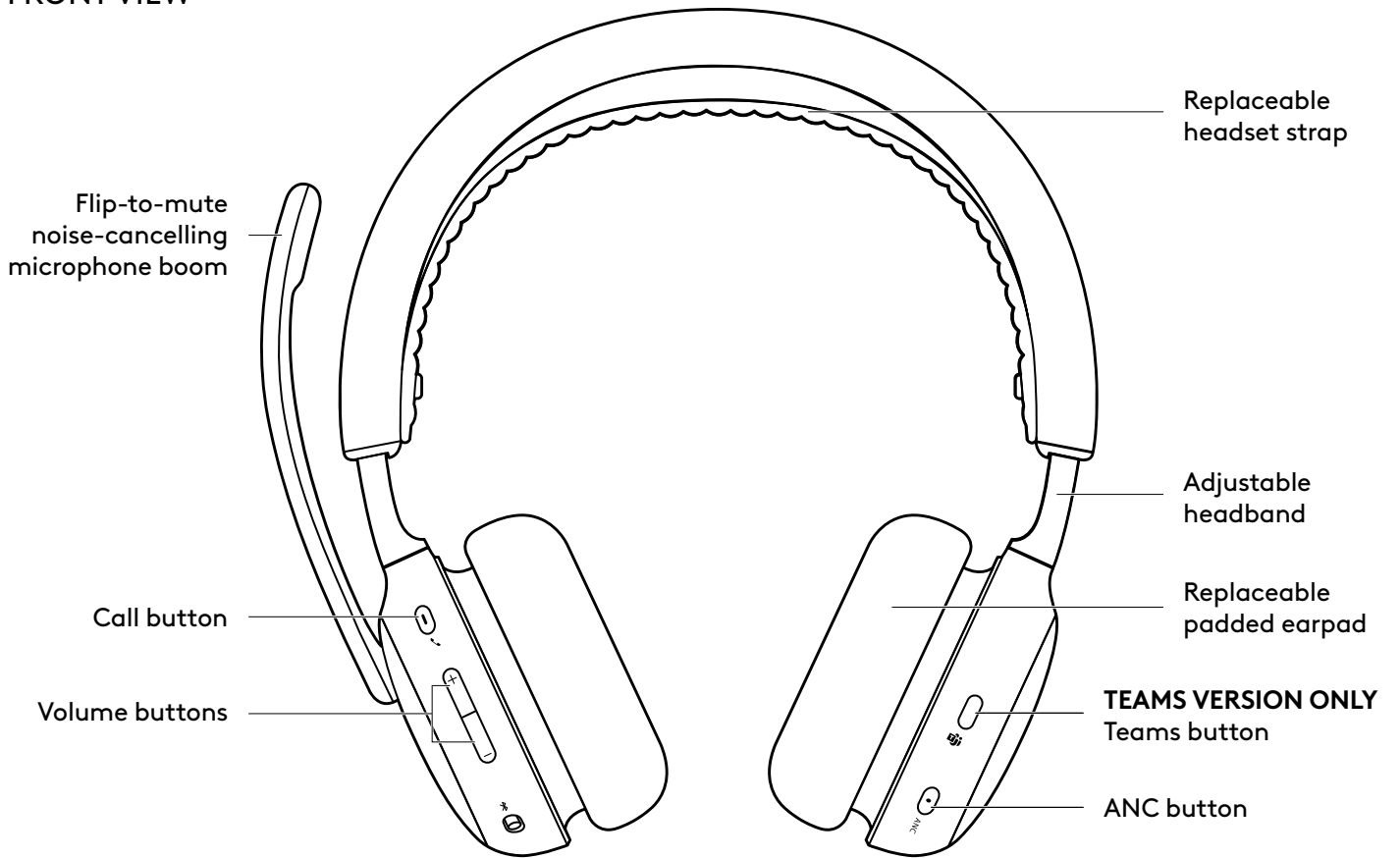

BOTTOM VIEW

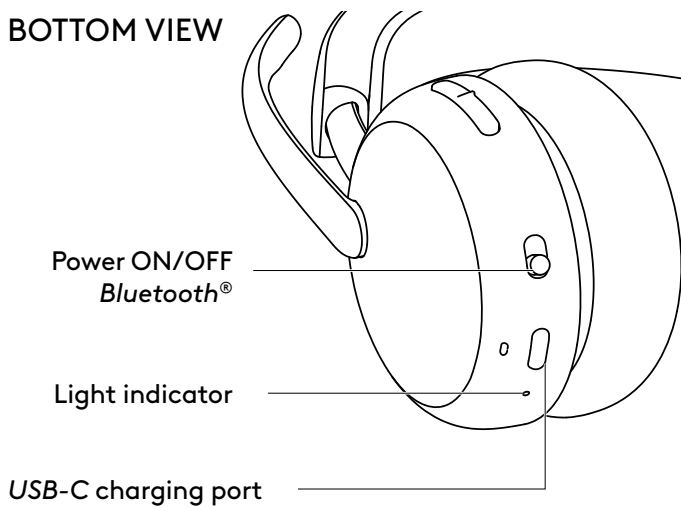

USB RECEIVER AND ADAPTER

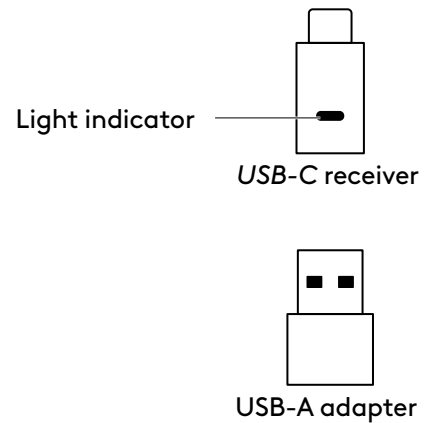

WHAT'S IN THE BOX

1. Headset
2. *USB-C* receiver
3. *USB-A* adapter
4. *USB-C* to *C* charging cable
5. Travel bag
6. User documentation

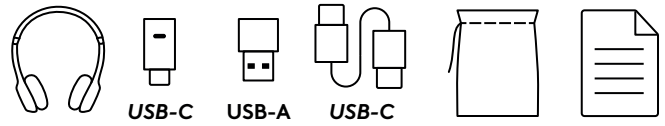

POWER ON/OFF

1. Slide power switch to the center.
2. Once powered on, the light indicator turns white.
3. To power off, slide power switch to the power icon.

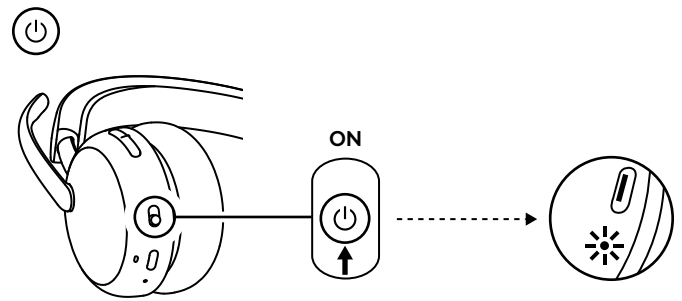

PAIRING VIA USB RECEIVER

1. **USB-C**
Insert the receiver into the computer *USB-C* port.
USB-A
Insert the *USB-C* receiver into the *USB-A* adapter. Then insert the adapter into the computer *USB-A* port.
2. The headset is already paired to the receiver it ships with. Just power on the headset. Once successfully paired, the light indicator on the receiver will remain solid white. The light indicator on the headset will turn solid white.
3. Make sure "Logi Zone Wireless 2 ES B2B" is selected on the computer sound setting.

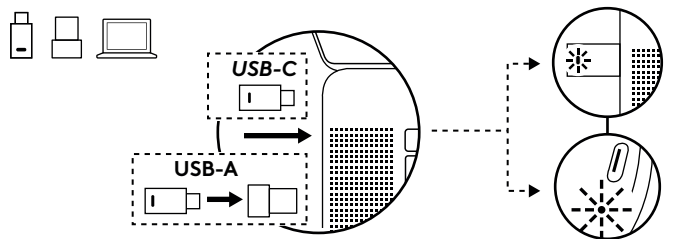

PAIRING VIA BLUETOOTH®

1. Slide power switch to the *Bluetooth*® icon and hold for 2 seconds. The light indicator will flash white rapidly.
2. Open *Bluetooth*® settings on your device.
3. Select "Logi Zone Wireless 2 ES B2B" in discoverable devices.
4. Once successfully paired, the light indicator will turn solid white.

Tip (when using Windows 10 only):

When the headset is paired to the laptop, if needed, go to the sound setting and select "Logi Zone Wireless 2 ES B2B Stereo" for the best music quality and select "Logi Zone Wireless 2 ES B2B Hands-Free" for calls.

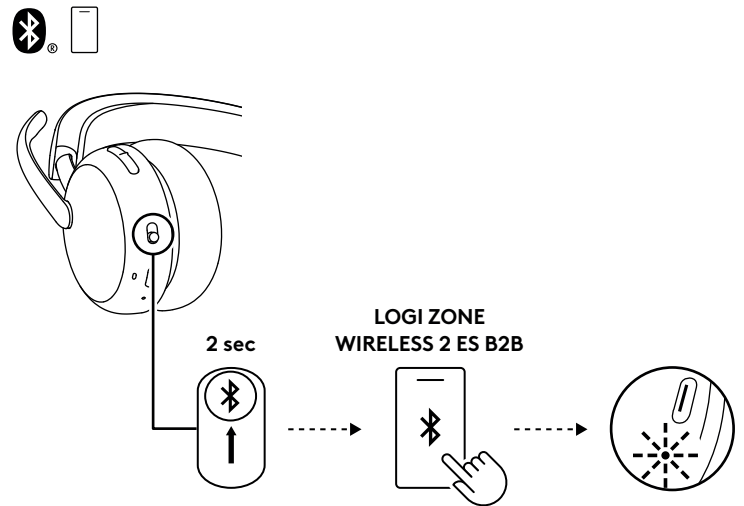

ADJUSTING HEADSET

1. Adjust the headset by sliding earcups up and down the headband.
2. Swivel earcups to fit on your ear.
3. It may be easier to adjust the headset on your head. Move the earcups up and down the headband until they sit comfortably on your ears.

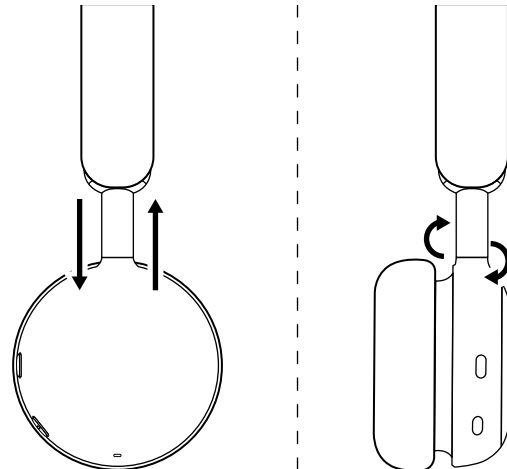

ADJUSTING THE MICROPHONE BOOM

The microphone boom rotates 270 degrees. Wear it on either the left or right side. The audio channel will switch automatically, depending on the direction you are wearing the microphone.

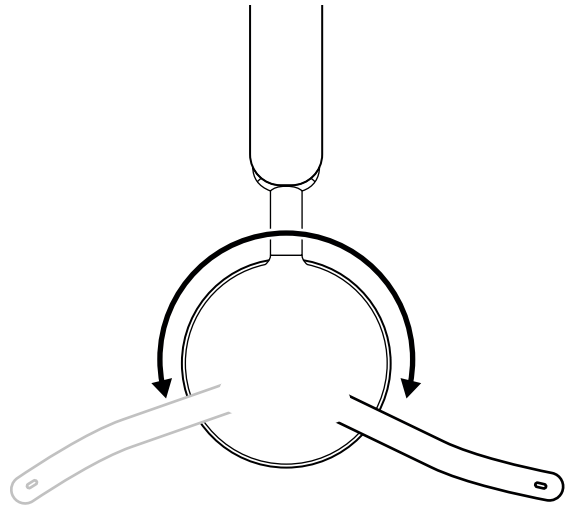

Mic boom should be placed close or next to your mouth, aligned with the corner of the mouth.

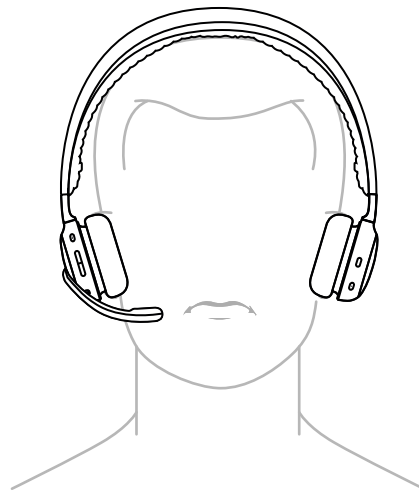

CHARGING

The headset automatically powers off when left idle.

Sleep timer can be changed in Logi Tune app.

The headset indicator light will turn RED when the battery is low.



CHARGING VIA USB CABLE

1. Plug one end of the cable to the *USB-C* port on the bottom of the earcup and the other end into the *USB-C* charging port on your computer, dock, or a power adapter.
2. Indicator light will be a breathing white light for charging.
3. Indicator light will be solid white when fully charged.
 - 2 hours of charging fully charges the battery.
 - 5 minutes will give you up to 1 hour of talk time.*
4. The headset can be used with a receiver and *Bluetooth*® paired while charging. It can also be used as a corded headset with the *USB-C* cable connected while the headset is powered off.

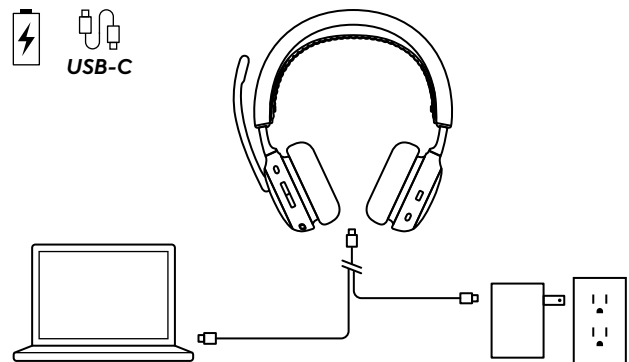
* Battery life was measured from fully charged to automatic shut-off, with ANC off, utilizing 50% volume for both talk time and listening time.

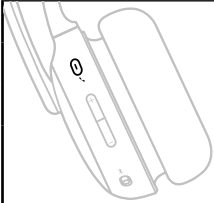
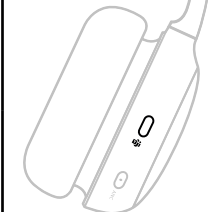
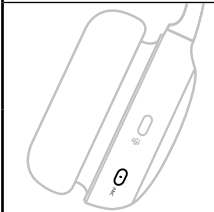

HEADSET CONTROLS

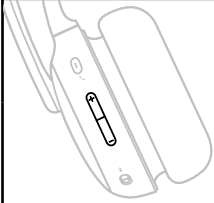
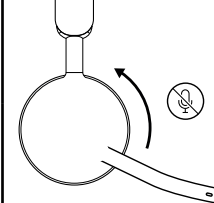
Button	Usage		Action
	Call controls	Answer / End call	Short press
		Resume on-hold call	
	Voice assistance	Trigger voice assistant (when there is no call activity)	2 seconds press
	Teams call controls (Teams version only)	Teams activities	Short press
		2 seconds press	
	ANC controls	Toggle between ANC and Transparency On	Short press
		ANC off	2 seconds press
	Media controls (Enable with Logi Tune)	Play / Pause	Short press
		Next track	Double press
		Previous track	Triple press
	Volume controls	Volume up	Short press up
		Volume down	Short press down
	Mute	Mute on	Mic boom flip up
		Mute off	Mic boom flip down

Note:

- Teams activities are only functional when Teams is running on an unlocked computer.
- Media control functionality depends on the type of application. It can only be set up through the Logi Tune app.
- Call activities are always the first priority over media streaming. When two devices are connected, the *Bluetooth*[®] connection will be prioritized over the receiver. When two *Bluetooth*[®] devices are connected, the last active device will take a priority over the other. And the priority between two *Bluetooth*[®] devices can be customized on Logi Tune app under Connected devices.
- To know more about Teams button, visit the *Microsoft Support* page: Use the *Microsoft Teams* button on your certified Teams device.
- Voice prompts indicate when the mic is mute on/off.

Tip: ANC can be customized on Logi Tune app.

ACTIVE NOISE CANCELLATION (ANC)

ANC blocks out the noise around you to help you concentrate on the task at hand.

- Press the ANC button on the side of the earcup to toggle between ANC and Transparency mode.
- There will be voice prompts when switching between modes.

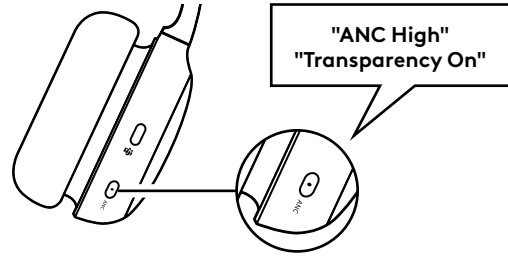

Note: ANC button can be customized to cycle through up to 5 different modes on Logi Tune app.

HEADSET LIGHT INDICATOR

Light		Status
White	Solid	Power on
		Connected to a device
		Battery fully charged
	Pulsing	Battery charging
	Flashing	Incoming call
Bluetooth® pairing mode		
Red	Blinking	Low battery
	Solid	Mute on
Purple and White	Blinking	Headset firmware updating

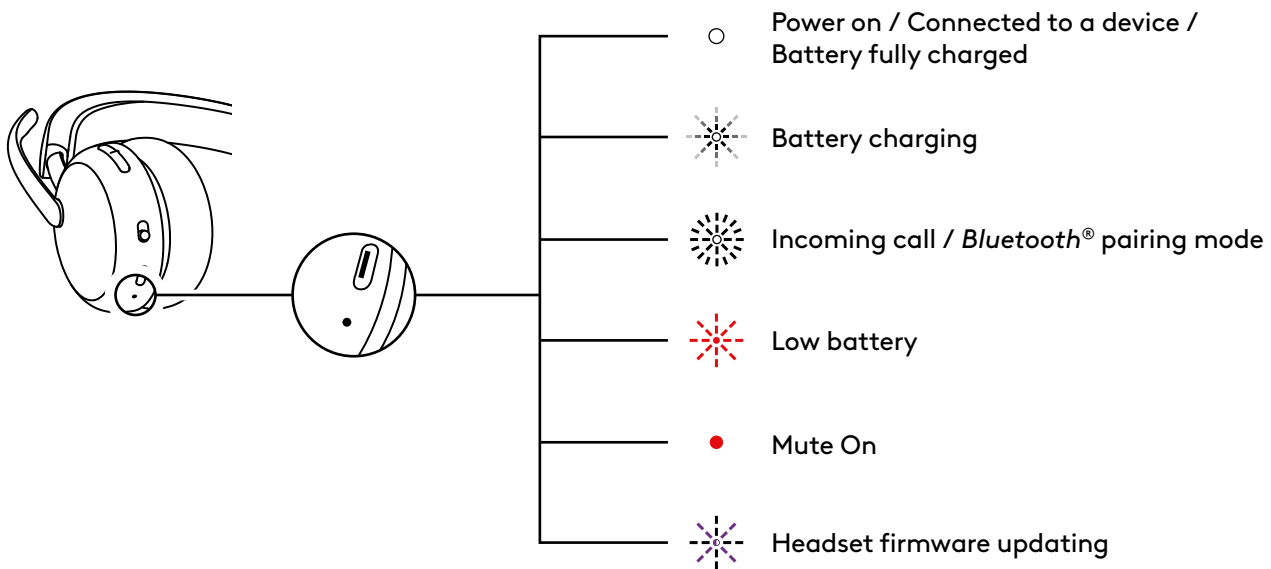

RECEIVER INDICATOR LIGHT

Microsoft Teams version		
	Light	Status
White	Solid	Connected
	Repeat flashing on and off	Incoming call
Purple	Solid	Connected to Teams
	Pulsing	Connecting to Teams / Teams notifications
	Flashing 3 times and off	Not connected to Teams
	Flashing for 10 seconds and off	Failed to connect to Teams
Red	Solid	Mute on
Blue	Flashing	Pairing

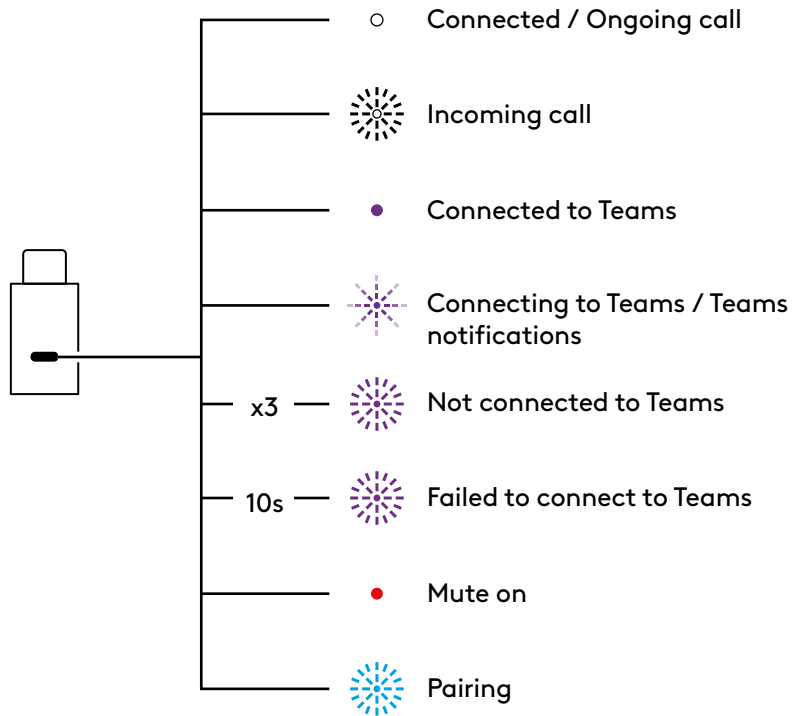

UC version		
Light		Status
White	Solid	Connected
		Ongoing call
	Repeat flashing on and off	Incoming call
Red	Solid	Mute on
Blue	Flashing	Pairing



AUDIO OVER USB (DENSITY-FRIENDLY)

If your audio is unstable during a call because there are too many wireless devices nearby (high density), the headset can be used as a corded headset.

1. Turn off the headset.
2. Connect the headset to the USB cable provided. And plug the other side of the *USB-C* cable into the *USB-C* port on your computer.
3. Make sure "Logi Zone Wireless 2 ES B2B-USB" is selected on the audio device setting.

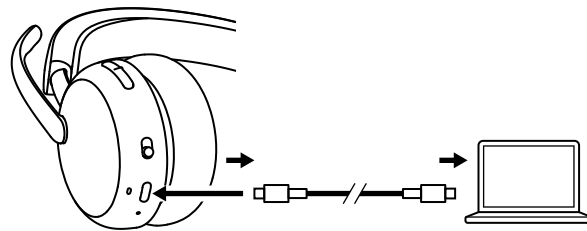

Note: Headset would be charged during this mode. Button controls may not be available in this mode.

LOGI TUNE

Logi Tune helps boost your headset performance with periodic software and firmware updates.

Learn more and download Logi Tune at logitech.com/tune, the *Apple App Store* or *Google Play* store.



ADJUSTING SIDETONE

Sidetone lets you hear your own voice during conversations so you are aware of how loud you are talking. In Logi Tune app, select the sidetone feature, and adjust the dial accordingly.

- A higher number means you hear more external sound.
- A lower number means you hear less external sound.

AUTO SLEEP TIMER

By default, your headset will automatically power off when not in use for 30 mins. Adjust the sleep timer in the Logi Tune app.

MIC EQ

Customize Mic EQ in Logi Tune to adjust your voice to sound brighter or deeper.

HEARING PROTECTION

Zone Wireless 2 ES for Business provides three types of protection to help you hear safely.

Peak limiting: Audio volume is always limited at 100dBA to prevent hearing damages.

Anti-startle protection: It eliminates sudden audio spikes to avoid acoustic shocks as per Australian G616 guideline. This can be enabled on the Logi Tune app and applies to call activities only.

Noise exposure over time: It protects your ears from the noise exposure over an 8-hour period with a limit up to 85dBA as per Australian G616 guideline. This can be enabled on the Logi Tune app and applies to call activities only.

UPDATE YOUR HEADSET

It is recommended to update both your headset and receiver. To do so, download Logi Tune from logitech.com/tune and check for available firmware updates.

Note: Turn off and on the headset after the update is completed to make sure it is successfully done.

RECONNECT YOUR HEADSET

In case the headset is disconnected to the receiver, you can reconnect your headset via Logi Tune.

1. Plug *USB-C* receiver or *USB-A* adapter with the *USB-C* receiver into the computer *USB* port.
2. Power on the headset by sliding the power switch to the center.
3. Open Logi Tune Desktop on your computer.
4. Select "Zone Receiver" from the dashboard.
5. Wait while it is looking for the previously connected headset.
6. If no headset is shown as connected to the receiver, click "Pair headset".
7. Enter pairing mode on the headset by sliding the power switch to the *Bluetooth*[®] icon and holding it for 2 seconds. The light indicator will flash white rapidly.
8. Once successfully paired, the light indicator on the receiver and on the headset will turn solid white.

RESET YOUR HEADSET

To reset your headset back to its original state, power headset on, long press the volume up button and slide power button to the pairing mode for 5 seconds. The headset is successfully reset when the headset light indicator blinks fast in red and white 3 times and turns off.

DIMENSIONS

Headset:

Height x Width x Depth:
185.2 x 183.6 x 73.0 mm

Weight:

212 g

Receiver:

Height x Width x Depth:
26.8 x 12.4 x 6.2 mm

Adapter:

Height x Width x Depth:
24.5 x 15.4 x 8.7 mm

SYSTEM REQUIREMENTS

Works with common calling applications across almost all platforms and operating systems. Works with *Windows*, *Mac*, or *Chrome*-based computer via *USB-C*, *USB-A*, *Bluetooth*[®] and *iOS* or *Android Bluetooth*[®] enabled devices.

TECHNICAL SPECIFICATIONS

Microphone type: 2 noise-canceling mics with AI-based algorithms and Mic EQ

Frequency response (headset): 20 Hz - 20 kHz (music mode), 100 Hz - 8 kHz (talk mode)

Frequency response (microphone): 100 Hz - 8 kHz

Battery type: Built-in battery (lithium ion)

Battery life (talk time)*: Up to 20 hrs (ANC on), up to 25 hrs (ANC off)

Battery life (listening time)*: Up to 25 hrs (ANC on), up to 48 hrs (ANC off)

Bluetooth[®] version: 5.3

Wireless range*: Up to 50 m/170 ft (open field line of sight)

USB-C to C charging cable length: 1.5 m

Audio compliance: EN 50332-2 compliant

* Battery life was measured from fully charged to automatic shut-off, with ANC off, utilizing 50% volume for both talk time and listening time.

www.logitech.com/support/zonewireless2es-b

了解您的产品

正视图

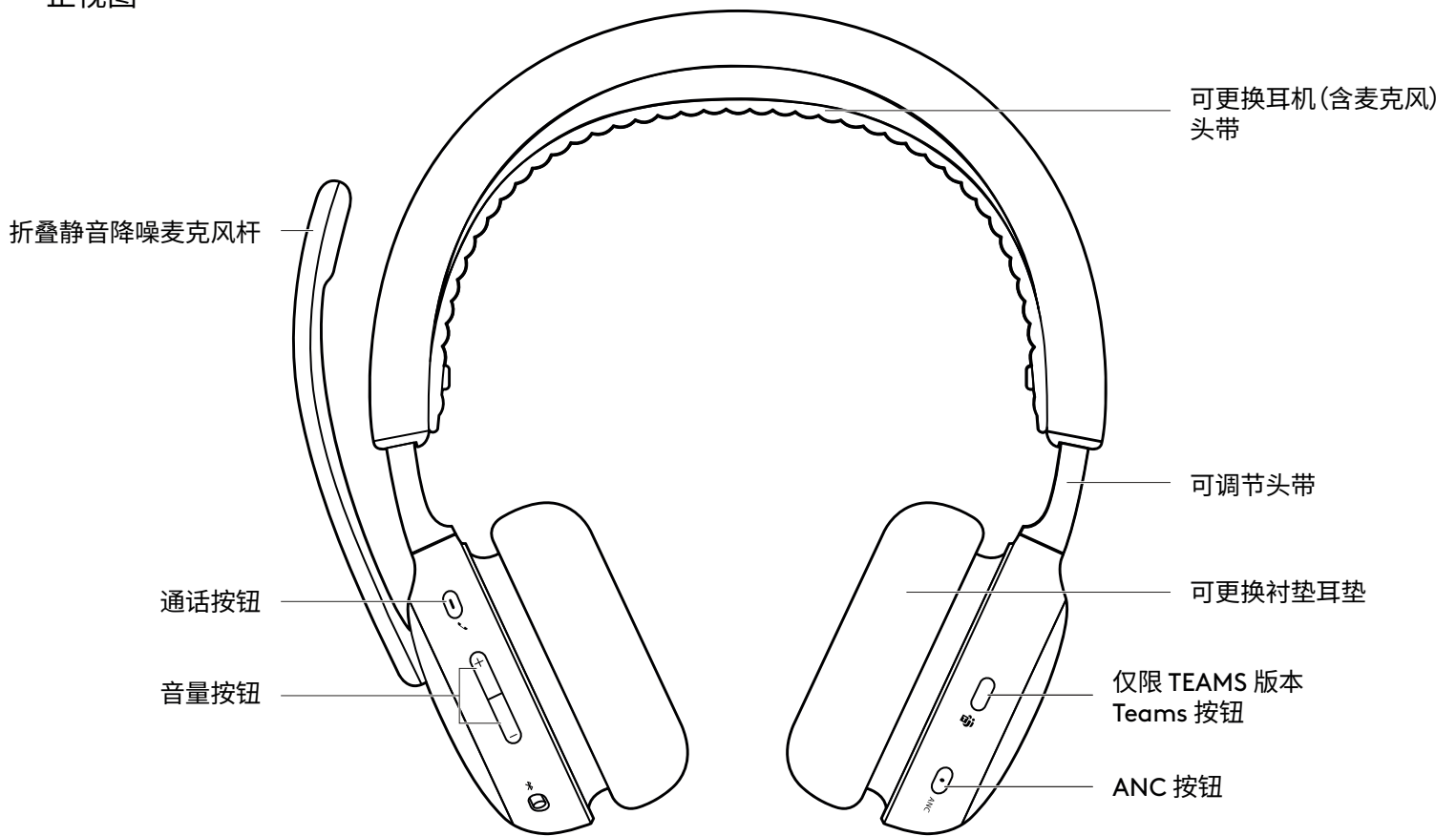

底视图

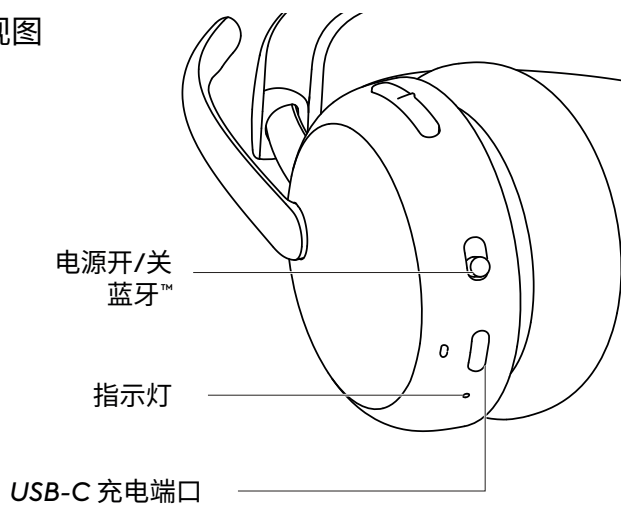

USB 接收器和适配器

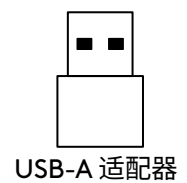
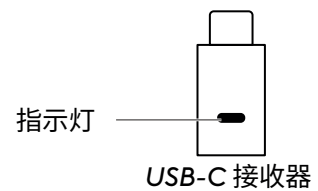

包装内容

1. 耳机(含麦克风)
2. USB-C 接收器
3. USB-A 适配器
4. USB-C 至 C 充电线
5. 便携包
6. 用户文档

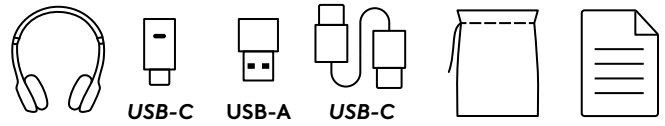

电源开/关

1. 将电源开关滑至中央。
2. 打开电源后, 指示灯变为白色。
3. 要关闭电源, 将电源开关滑至电源图标。

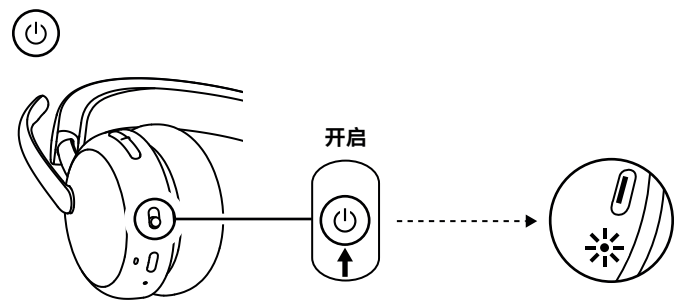

通过 USB 接收器配对

1. **USB-C**
将接收器插入电脑的 USB-C 端口。

USB-A

将 USB-C 接收器插入 USB-A 适配器。将适配器插入电脑的 USB-A 端口。

2. 耳机(含麦克风)已与随附的接收器配对。只需打开耳机(含麦克风)的电源即可。成功配对后, 接收器指示灯将常亮白色。耳机(含麦克风)指示灯将常亮白色。
3. 确保在电脑声音设置中选择了“Logi Zone Wireless 2 ES B2B”。

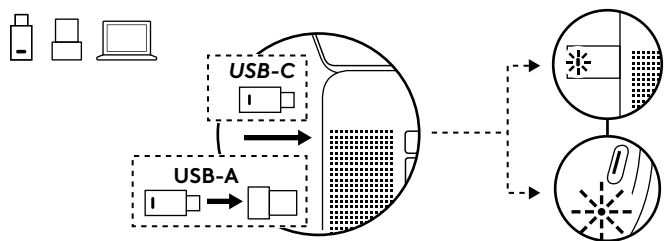

通过蓝牙™ 配对

1. 将电源开关滑至蓝牙® 图标并保持 2 秒钟。指示灯将快速闪烁白光。
2. 在设备上打开蓝牙™ 设置。
3. 在可发现设备中选择“Logi Zone Wireless 2 ES B2B”。
4. 成功配对后，指示灯将常亮白色。

提示 (仅限使用 Windows 10 时)：

耳机 (含麦克风) 与笔记本电脑配对后，如果需要，请前往声音设置并选择“Logi Zone Wireless 2 ES B2B 立体声”以获得理想的音乐播放质量，并选择“Logi Zone Wireless 2 ES B2B 免提”用于通话。

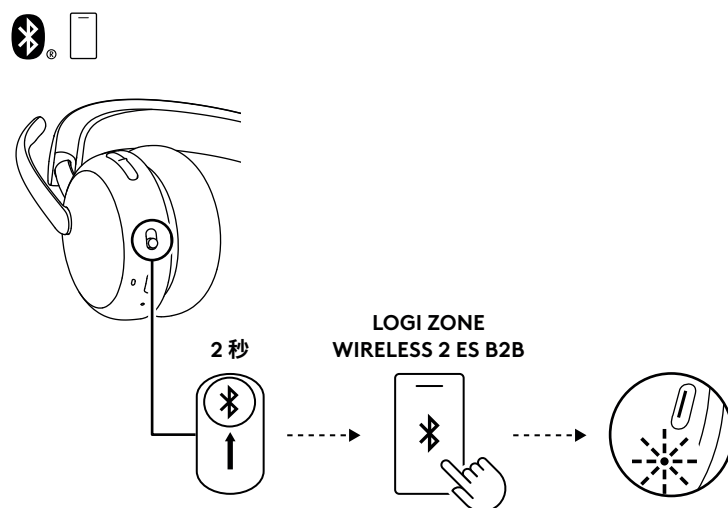

调整耳机 (含麦克风)

1. 通过头带上下滑动耳罩调节耳机 (含麦克风) 以佩戴。
2. 旋转耳罩以贴合耳部。
3. 带好耳机 (含麦克风) 后将使得耳机 (含麦克风) 更易调整。在头带处上下移动耳罩，直至舒适贴合耳部。

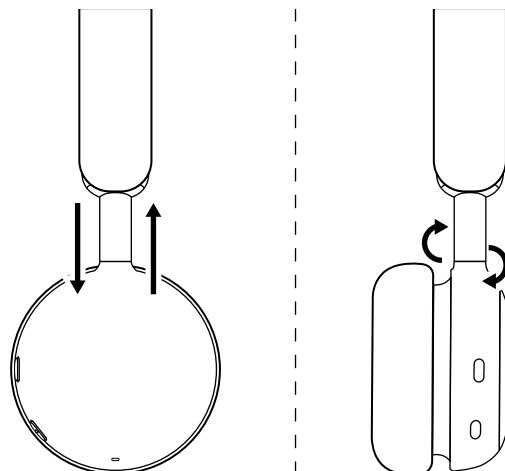

调整麦克风杆

麦克风杆可旋转 270 度。将其佩戴于左右均可。音频通道将自动切换, 具体取决于您佩戴麦克风的方位。

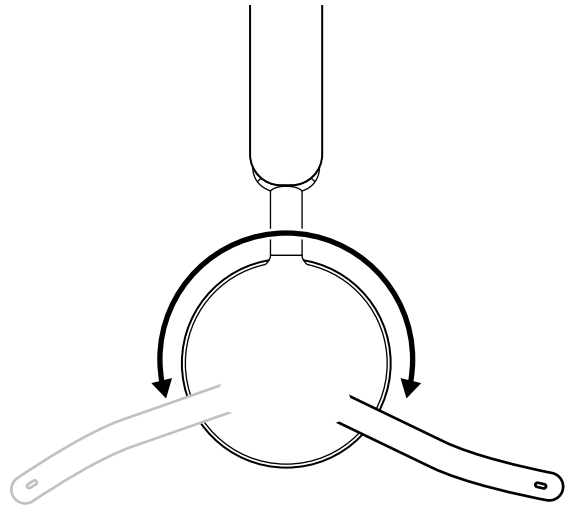

麦克风杆应靠近嘴部放置, 与嘴角对齐。

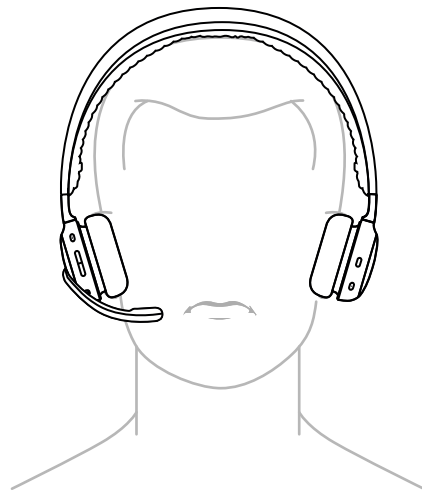

正在充电

耳机(含麦克风)会在闲置时自动关机。

可以在 Logi Tune 应用程序中调节睡眠定时器。

电量不足时,耳机(含麦克风)指示灯将变为红色。



通过 USB 线缆充电

1. 将数据线的一端插入耳罩底部的 USB-C 端口,另一端插入电脑、扩展坞或电源适配器的 USB-C 充电端口。
2. 充电时指示灯将显示为白色呼吸灯。
3. 充电完成后,指示灯将常亮白色。
 - 完全充电需要 2 小时。
 - 5 分钟充电可提供长达 1 小时的通话时间*。
4. 充电时,耳机(含麦克风)可通过接收器和已配对的蓝牙®设备使用。耳机(含麦克风)关闭状态下,可通过 USB-C 线缆连接,用作有线耳机(含麦克风)。

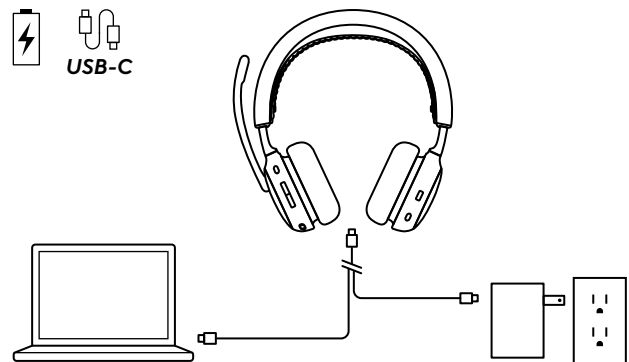
* 此电池使用时长的测量为从完全充电到自动关闭,在关闭ANC功能的情况下,通话时间和聆听时间均采用 50% 的音量。电池使用时长依用户、环境及计算条件而异。

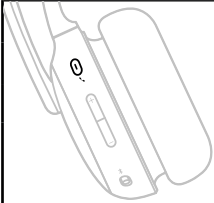
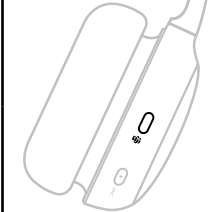
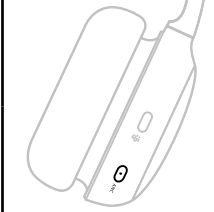

耳机(含麦克风)控制

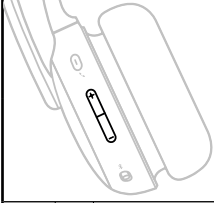
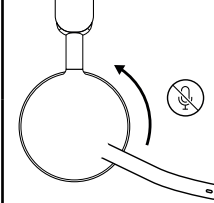
按钮	使用		操作
	通话控制	接听/结束通话	短按
		恢复保持的通话	
	语音助手	触发语音助手 (无通话活动时)	按 2 秒
	Teams 通话控制 (仅适用于 Teams 版本)	Teams 行为	短按
			按 2 秒
	ANC 控制	在 ANC 和通透模式之间切换	短按
		ANC 关闭	按 2 秒
	媒体控制 (通过 Logi Tune 启用)	播放/暂停	短按
		下一曲目	按两次
		上一曲目	按三次
	音量控制	音量上升	短按“上升”
		音量下降	短按“下降”
	静音	静音开启	麦克风杆向上翻转
		取消静音	麦克风杆向下翻转

注意：

- 仅当 Teams 运行于未锁定的电脑上时，Teams 活动才有效。
- 媒体控制功能取决于应用程序的类型。只能通过 Logi Tune 应用程序进行设置。
- 通话活动始终优先于媒体流。连接两个设备时，蓝牙™ 连接的优先级高于接收器连接。连接两个蓝牙® 设备时，最后一个处于活动状态的设备将优先于另一个设备。两个蓝牙® 设备之间的优先级可以在 Logi Tune 应用程序的已连接设备下自定义。
- 欲了解关于 Teams 按钮的更多信息，请访问 [Microsoft 支持页面](#)：使用已获认证的 Teams 设备上的 *Microsoft Teams* 按钮。
- 语音提示会指示麦克风静音状态。

提示：可在 Logi Tune 应用程序中自定义 ANC。

主动降噪 (ANC)

ANC 可以阻隔您周围的噪音, 帮助您专注于手头的任务。

- 按下耳罩侧面的 ANC 按钮可在 ANC 和通透模式之间切换。
- 切换模式时会有语音提示。

注意: ANC 按钮可在 Logi Tune 应用程序中自定义设置为循环切换最多 5 种不同的模式。

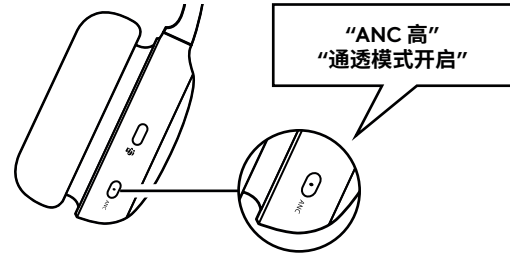

耳机(含麦克风)指示灯

指示灯		状态
白色	常亮	开机
		已连接设备
		电量充足
	闪烁	正在充电
	闪烁	通话呼入
红色	闪烁	蓝牙™ 配对模式
	常亮	低电量
紫色和白色	闪烁	静音开启
		耳机(含麦克风)固件更新

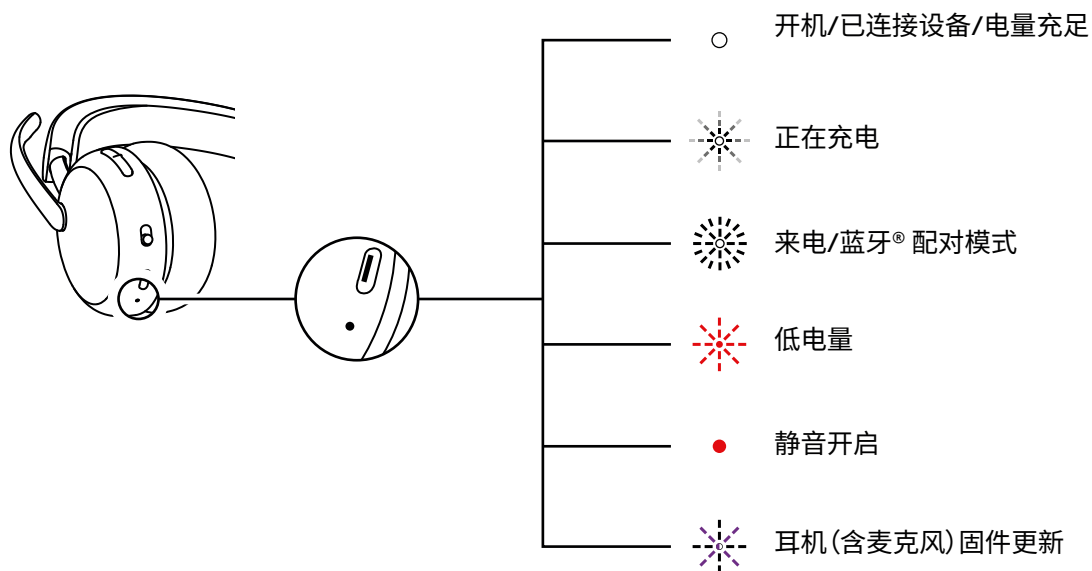

接收器指示灯

Microsoft Teams 版本		
指示灯		状态
白色	常亮	已连接
		通话中
	反复点亮和熄灭	通话呼入
紫色	常亮	已连接 Teams
	闪烁	正在连接 Teams/Teams 通知
	闪烁 3 次后熄灭	未连接 Teams
	闪烁 10 秒后熄灭	无法连接 Teams
红色	常亮	静音开启
蓝色	闪烁	正在配对

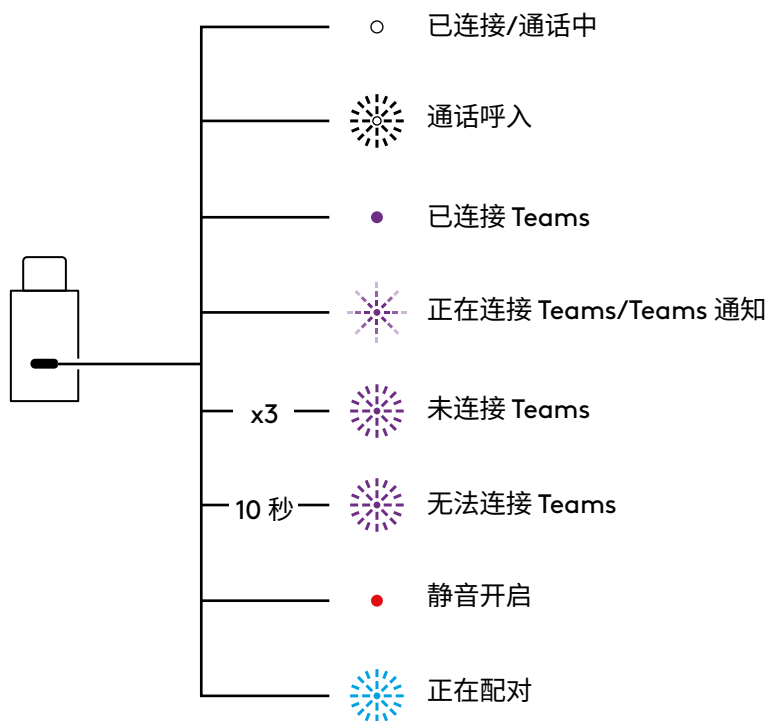

UC 版		
指示灯		状态
白色	常亮	已连接
	反复点亮和熄灭	通话中
红色	常亮	静音开启
蓝色	闪烁	正在配对

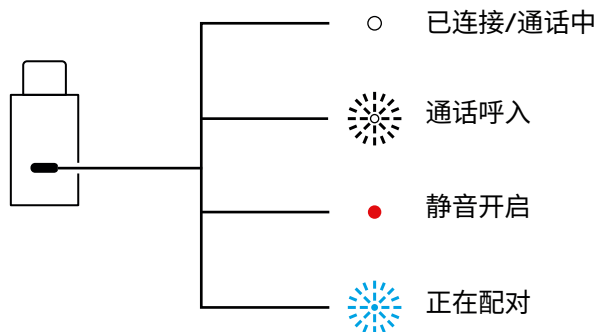

USB 音频(高密度)

如果由于附近的无线设备过多(高密度)而导致通话过程中音频不稳定,可以将耳机(含麦克风)用作有线耳机(含麦克风)。

1. 关闭耳机(含麦克风)。
2. 将耳机(含麦克风)连接至随附的 USB 线缆。将 USB-C 线缆的另一端插入电脑的 USB-C 端口。
3. 确保在音频设备设置中选择“Logi Zone Wireless 2 ES B2B-USB”。

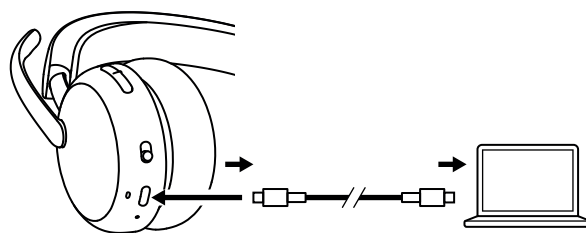

注意: 在此模式下,耳机将进行充电。在此模式下,按钮控制可能不可用。

LOGI TUNE

Logi Tune 通过定期的软件和固件更新帮助改善耳机(含麦克风)性能。请在 logitech.com/tune、*Apple App Store* 或 *Google Play* 商店中进一步了解并下载 Logi Tune。



调节侧音

侧音让您可以在对话中听到自己的声音,以了解自己的说话音量。在 Logi Tune 应用程序中选择侧音功能,并相应调节拨盘。

- 数字越大表示您听到的外部声音越多。
- 数字越小表示您听到的外部声音越少。

自动睡眠定时器

默认情况下,耳机(含麦克风)会在闲置 30 分钟后自动关机。在 Logi Tune 应用程序中调节睡眠定时器。

麦克风均衡器

在 Logi Tune 中自定义麦克风均衡器,调整您的声音,使其听起来更清亮或更低沉。

听力保护

Zone Wireless 2 ES for Business 提供三种类型的保护,助您安全聆听。

峰值限制:音量阈值始终限制为 100 dBA,以防听力受损。

防护声音冲击:可根据澳大利亚 G616 指南要求,消除突发的音频尖峰信号以避免声震。此功能可在 Logi Tune 应用程序中启用且仅应用于通话活动。

噪声暴露随时间的变化:可根据澳大利亚 G616 指南要求,在 8 小时内保护您免受噪音影响,最大噪声限制为 85dBA。此功能可在 Logi Tune 应用程序中启用且仅应用于通话活动。

更新耳机(含麦克风)

建议您及时更新耳机(含麦克风)和接收器。为此,请从 logitech.com/tune 下载 Logi Tune, 并检查是否有可用的固件更新。

注意: 更新完成后,先关闭耳机(含麦克风)电源,再重新打开,以确保更新成功。

重新连接耳机(含麦克风)

如果耳机(含麦克风)与接收器的连接断开,可以通过 Logi Tune 重新连接耳机(含麦克风)。

1. 将 USB-C 接收器或已连接 USB-C 接收器的 USB-A 适配器插入电脑的 USB 端口。
2. 将电源开关滑至中央,打开耳机(含麦克风)。
3. 在电脑上打开 Logi Tune Desktop。
4. 从仪表板中选择“Zone 接收器”。
5. 等待其查找此前连接过的耳机(含麦克风)。
6. 如果接收器未连接任何耳机(含麦克风),点击“配对耳机(含麦克风)”。
7. 将电源开关滑至蓝牙® 图标并保持 2 秒钟,进入耳机(含麦克风)的配对模式。指示灯将快速闪烁白光。
8. 配对成功后,接收器和耳机(含麦克风)的指示灯将常亮白色。

重置耳机(含麦克风)

要将耳机(含麦克风)重置为初始状态,请打开耳机(含麦克风)电源,长按音量上升按钮,然后将电源按钮滑至配对模式并保持 5 秒钟。耳机(含麦克风)指示灯快速闪烁红白 3 次后熄灭,表示耳机(含麦克风)重置成功。

尺寸

耳机(含麦克风):

高 x 宽 x 深:
约 185.2 x 约 183.6 x 约 73.0 毫米

重量:

约 212 克

接收器:

高 x 宽 x 深:
约 26.8 x 约 12.4 x 约 6.2 毫米

适配器:

高 x 宽 x 深:
约 24.5 x 约 15.4 x 约 8.7 毫米

系统要求

兼容多数平台和操作系统的常用通话应用程序。通过 USB-C、USB-A、蓝牙® 兼容 Windows、Mac 或 Chrome 电脑,并兼容支持蓝牙® 的 iOS 或 Android 设备。

技术规格

麦克风类型:2 个降噪麦克风,搭载基于人工智能的算法及麦克风均衡器

频率响应(耳机(含麦克风)):20 Hz-20 kHz(音乐模式),100 Hz-8 kHz(通话模式)

频率响应(麦克风):100 Hz-8 kHz

电池类型:内置电池(锂离子)

电池续航(通话时间)*:最长 20 小时(ANC 开启),最长 25 小时(ANC 关闭)

电池续航(播放时间)*:最长 25 小时(ANC 开启),最长 48 小时(ANC 关闭)

蓝牙™版本:5.3

无线范围*: 最远 50 米(无遮挡)

USB-C 至 C 充电线缆的线缆长度: 约 1.5 米

音频合规性:符合 EN 50332-2 标准

* 此电池使用时长的测量为从完全充电到自动关闭,在关闭ANC功能的情况下,通话时间和聆听时间均采用 50% 的音量。电池使用时长依用户、环境及计算条件而异。

www.logitech.com/support/zonewireless2es-b

© 2025 Logitech. Logitech, Logi, Zone, and their logos are trademarks or registered trademarks of Logitech Europe S.A. and/or its affiliates in the U.S. and other countries. *Apple*, the *Apple* logo, *iOS*, and *Mac* are trademarks of Apple Inc., registered in the U.S. and other countries. *App Store* is a service mark of Apple Inc. *Android*, *Chrome*, *Google Play* and the *Google Play* logo are trademarks of Google LLC. The *Bluetooth*® word mark and logos are registered trademarks owned by Bluetooth SIG, Inc. and any use of such marks by Logitech is under license. *Microsoft Teams* and *Windows* are trademarks of the Microsoft group of companies. *USB-C* and all other 3rd party trademarks are the properties of their respective owners. Logitech assumes no responsibility for any errors that may appear in this manual. Information contained herein is subject to change without notice.

版权所有 © 2025 罗技。罗技、Logitech、Logi、Zone 及其标志为罗技欧洲公司和/或其美国及其他国家/地区附属公司的商标，并或已注册。*Apple*、*Apple* 徽标、*iOS* 和 *Mac* 是 Apple Inc. 在美国和其他国家/地区注册的商标。*App Store* 是 Apple Inc. 的服务商标。*Android*、*Chrome*、*Google Play* 和 *Google Play* 徽标是 Google LLC 的商标。蓝牙® 文字商标和标志为 Bluetooth SIG, Inc. 所有的注册商标，罗技对此类商标和标志的所有使用均已获得授权。*Microsoft Teams* 和 *Windows* 是 Microsoft 集团公司的商标。*USB-C* 和所有其它第三方商标均是各自所有者的财产。罗技对于本手册中可能出现的任何错误不承担任何责任。本手册中包含的信息如有更改，恕不事先通知。本说明书内所使用的数据如无特别说明均来自罗技有限公司和/或其关联公司和/或其指定的供应商。图片仅作说明之用，可能与实物有所差别。