

ZONE WIRED 2 FOR BUSINESS

Setup Guide
Guide d'installation

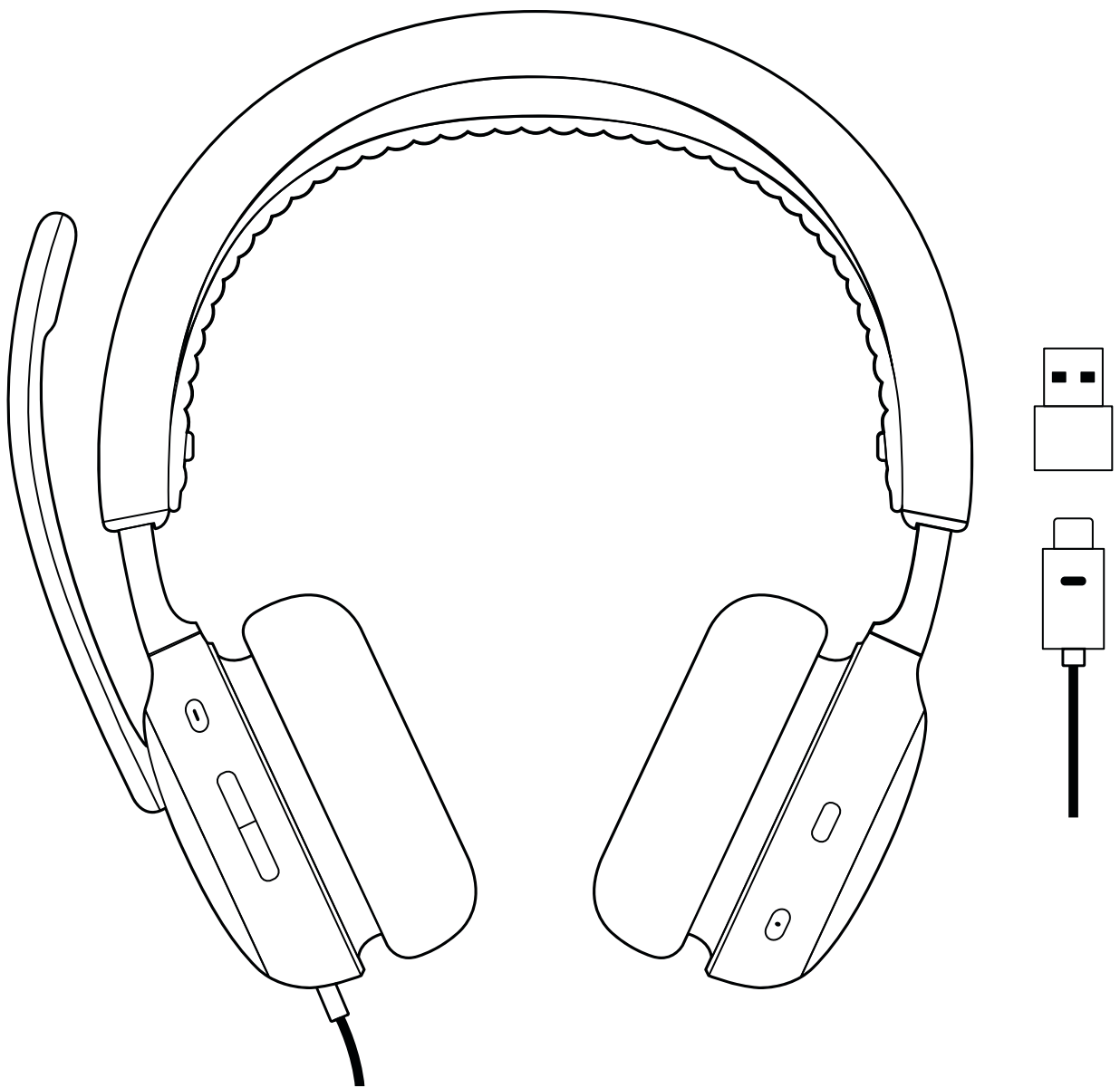

logitech®

CONTENTS

English 3

Français 11

Español (México). 19

Português (Brasil) 27

繁體中文 35

한국어 43

KNOW YOUR PRODUCT

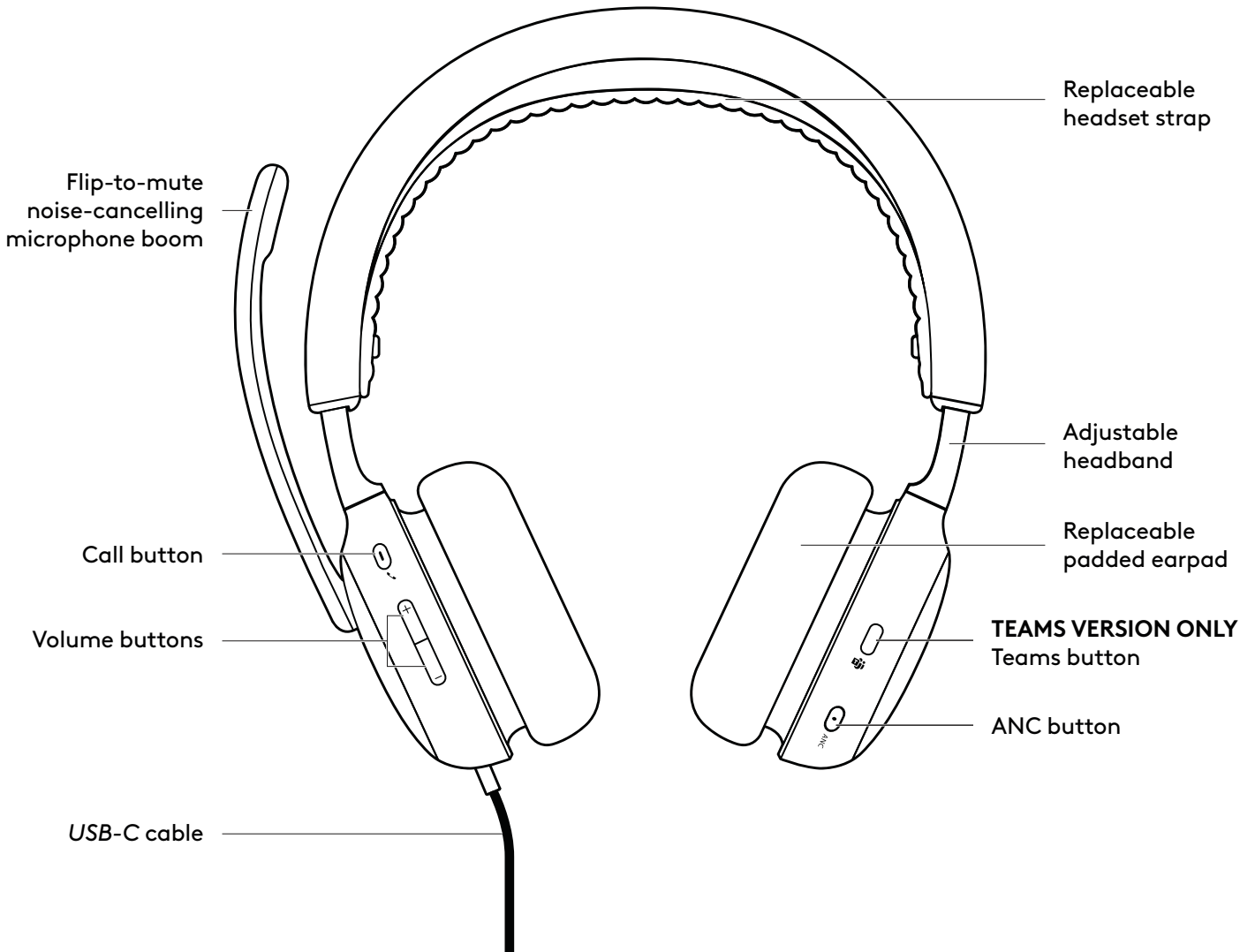

USB PLUG AND ADAPTER

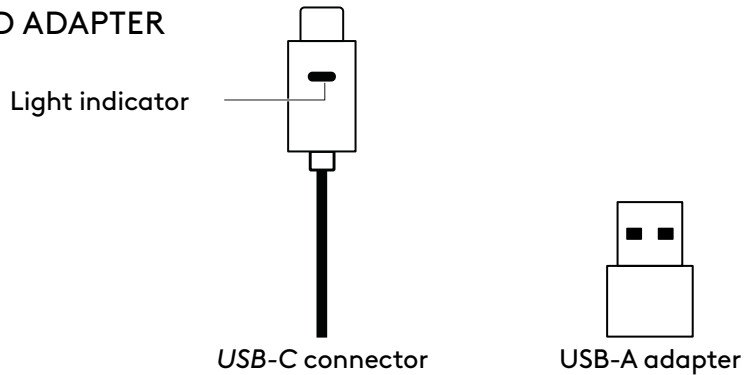

WHAT'S IN THE BOX

1. Headset
2. USB-A adapter
3. Travel bag
4. User documentation

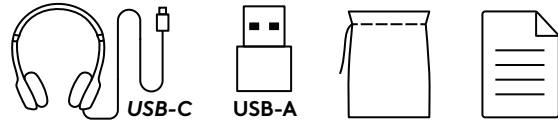

CONNECT YOUR HEADSET

Plug the *USB-C* connector into the computer *USB-C* port. Or use the provided *USB-A* adapter to plug the headset into the computer *USB-A* port.

Note: Only use the *USB-A* adapter with the provided headset.

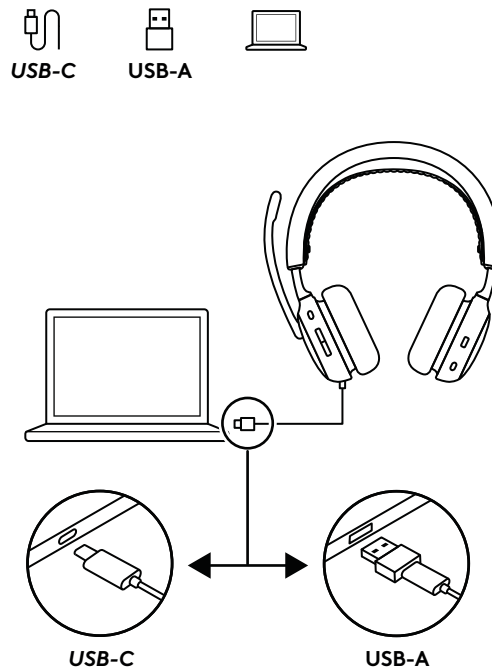

ADJUSTING HEADSET

1. Adjust the headset by sliding earcups up and down the headband.
2. Swivel earcups to fit on your ear.
3. It may be easier to adjust the headset on your head. Move the earcups up and down the headband until they sit comfortably on your ears.

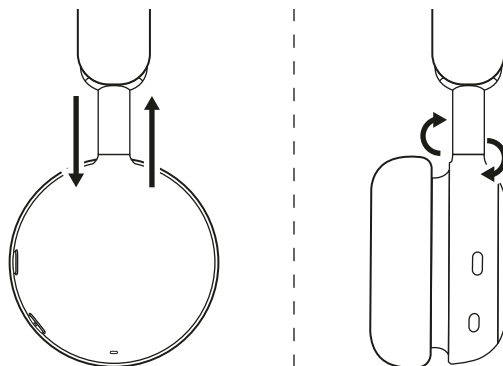

ADJUSTING THE MICROPHONE BOOM

The microphone boom rotates 270 degrees. Wear it on either the left or right side. The audio channel will switch automatically, depending on the direction you are wearing the microphone.

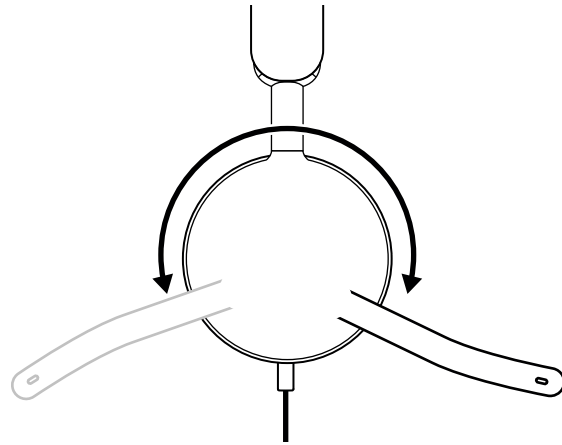

Mic boom should be placed close or next to your mouth, aligned with the corner of the mouth.

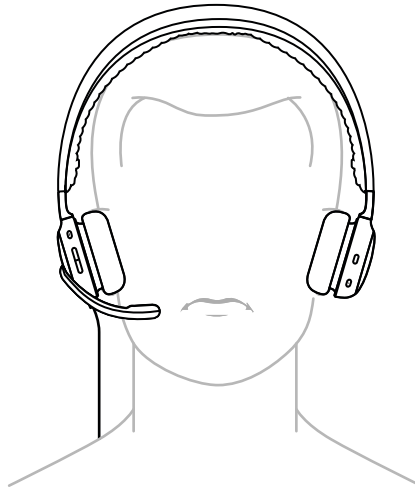

HEADSET CONTROLS

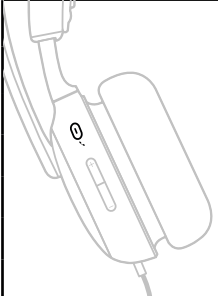
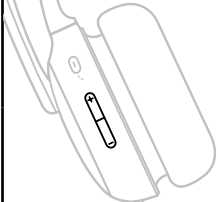
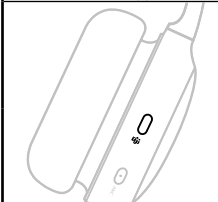
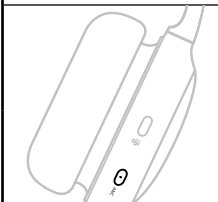
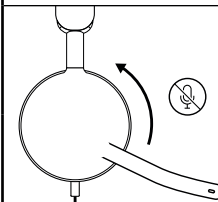
Button	Usage		Action
	Call controls¹	Answer / End call	Short press
		End Teams meeting	
		Resume on-hold call	
	Media controls (Enable with Logi Tune)	Reject call	2 seconds press
		Play / Pause	Short press
		Next track	Double press
	Previous track	Triple press	
	Volume controls	Volume up	Short press "+"
		Volume down	Short press "-"
	Teams controls (Teams version only)	Teams activities	Short press
	ANC controls¹	Toggle between ANC and Transparency On	Short press
			ANC off
	Mute	Mute on	Mic boom flip up
			Mute off

Note:

- Teams activities are only functional when Teams is running on an unlocked PC or Mac. To know more about Teams button, visit the [Microsoft Support page: Use the Microsoft Teams button on your certified Teams device.](#)
- Voice prompts indicate when the mic is mute on/off.

ACTIVE NOISE CANCELLATION (ANC)

ANC blocks out the noise around you to help you concentrate on the task at hand.

- Press the ANC button on the side of the earcup to toggle between ANC and Transparency mode.
- There will be voice prompts when switching between modes.²

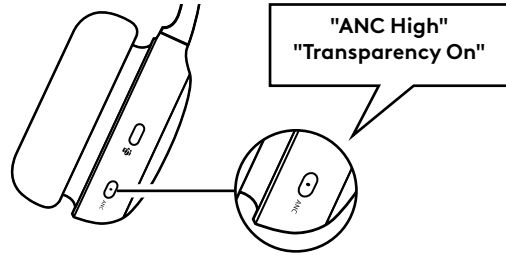

Note: ANC button can be customized to cycle through up to 5 different modes on Logi Tune app.

CONNECTOR LIGHT INDICATOR

Light		Status
White	Solid	Active Teams meeting
		Ongoing call
	Flashing	Incoming call
Red	Solid	Mute on
Purple	Solid	Connected to Teams
	Flashing	Connecting to Teams / Teams notifications
Purple and White	Blinking	Headset firmware updating

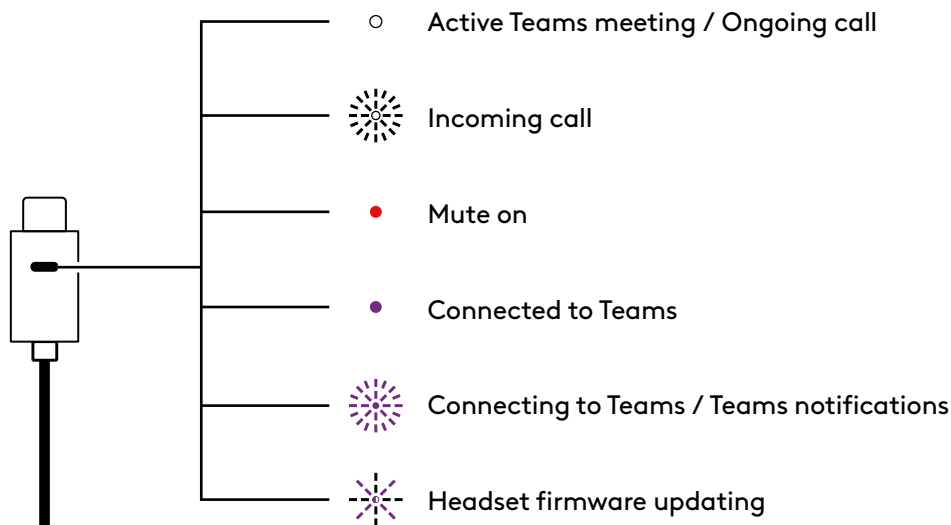

LOGI TUNE

Logi Tune helps boost your headset performance with periodic software and firmware updates. Learn more and download Logi Tune at logitech.com/tune.



ADJUSTING SIDETONE

Sidetone lets you hear your own voice while speaking so you are aware of how loud you are talking. In Logi Tune app, select the sidetone feature, wear your headset, adjust the setting while speaking.

- A higher number means you hear more external sound.
- A lower number means you hear less external sound.

MIC EQ

Customize Mic EQ in Logi Tune to adjust your voice to sound brighter or deeper.

HEARING PROTECTION

Zone Wired 2 for Business provides three types of protection to help you hear safely.

Peak limiting: Audio volume is always limited at 100dBA to prevent hearing damages.

Anti-startle protection: It limits sudden audio spikes to avoid acoustic shocks as per Australian G616 guideline. This can be enabled on the Logi Tune app and applies to call activities only.

Noise exposure over time: It monitors the average daily noise levels in calls not to exceed time-weighted average of 85dBA as per Australian G616 guideline. This can be enabled on the Logi Tune app and applies to call activities only.

ENABLE EQ FOR CALLS

Logi Tune now lets you apply equalizer settings to call audio in addition to music. Customize the sound you hear in calls with deeper bass, crisper treble, or any other preferred settings.

Turn on the "Enable EQ for calls" toggle in Logi Tune to use your customized equalizer settings for calls.

POWER SAVING MODE

Activate Power Saving Mode in Logi Tune to lower power usage from the device your headset is connected to.

When enabled, the headset will automatically turn off Active Noise Cancellation (ANC) and the light indicator after 30 minutes of inactivity to save power.

To wake up the headset, simply start using the headset by joining a call, listening to music or pressing any button.

UPDATE YOUR HEADSET

We recommend updating your headset to ensure optimal performance.

To do so, download Logi Tune from logitech.com/tune and check for available firmware updates.

DIMENSIONS

Headset:

Height x Width x Depth:
185.2 x 183.6 x 73.0 mm

Weight:

223.5 g

Adapter:

Height x Width x Depth:
24.5 x 15.4 x 8.7 mm

SYSTEM REQUIREMENTS

Works with common calling applications across almost all platforms and operating systems. Works with *Windows, Mac, or Chrome*-based computer³ via *USB-C* or *USB-A*.

TECHNICAL SPECIFICATIONS

Microphone type: 2 noise-canceling mics with AI-based algorithm and Mic EQ

Frequency response (headset): 20 Hz – 20 kHz (music mode), 100 Hz – 8 kHz (talk mode)

Frequency response (microphone): 100 Hz – 8 kHz

Cable length: 1.9 m

Audio compliance: EN 50332-2 compliant

FOOTNOTE

¹ Customize the button in Logi Tune. Check Logi Tune compatibility on logi.com/tune.

² The headset currently supports voice prompts in the following languages with the Logi Tune desktop app: English, French, German and Spanish. You can choose your preferred language in the app.

³ Device basic functions will be supported for operating systems that do not support Logi Tune.

www.logitech.com/support/zonewired2b

PRÉSENTATION DU PRODUIT

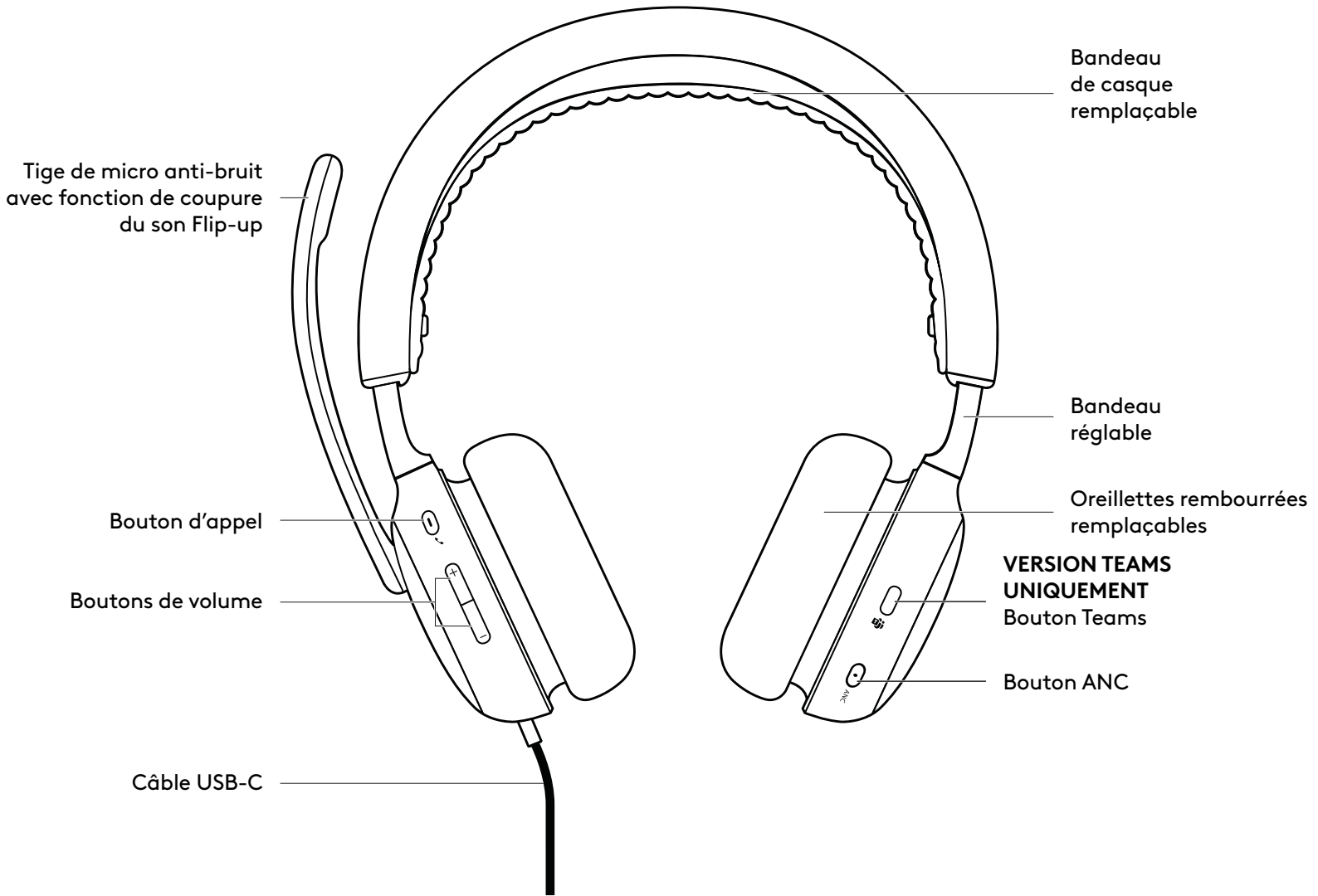

PRISE USB ET ADAPTATEUR

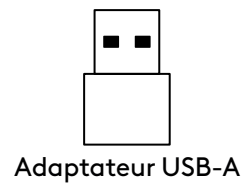
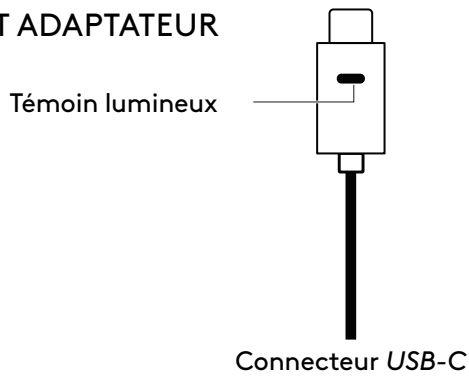

CONTENU

1. Casque
2. Adaptateur USB-A
3. Pochette de transport
4. Documentation utilisateur

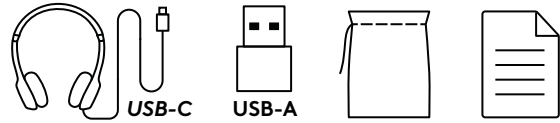

CONNECTER VOTRE CASQUE

Branchez le connecteur *USB-C* dans le port *USB-C* de l'ordinateur. Vous pouvez également utiliser l'adaptateur *USB-A* fourni pour brancher le casque au port *USB-A* de l'ordinateur.

Remarque: utilisez uniquement l'adaptateur *USB-A* avec le casque fourni.

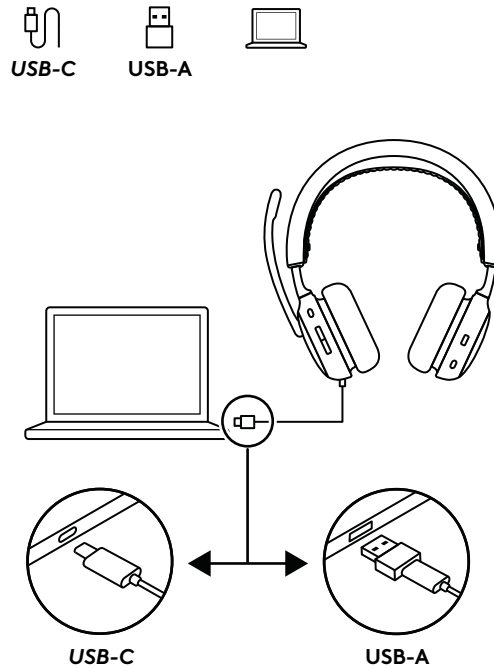

AJUSTEMENT DU CASQUE

1. Ajustez le casque en faisant glisser les oreillettes vers le haut et le bas du bandeau.
2. Oreillettes pivotantes pour s'adapter à votre oreille.
3. Il sera peut-être plus facile d'ajuster le casque sur votre tête. Déplacez les oreillettes vers le haut ou le bas du bandeau jusqu'à ce que le maintien sur vos oreilles soit confortable.

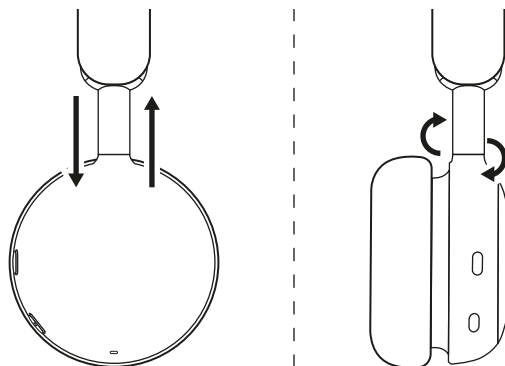

AJUSTEMENT DE LA TIGE DU MICRO

La tige du micro pivote sur 270 degrés. Portez-la à gauche ou à droite. Le canal audio bascule automatiquement, selon la direction dans laquelle vous portez le micro.

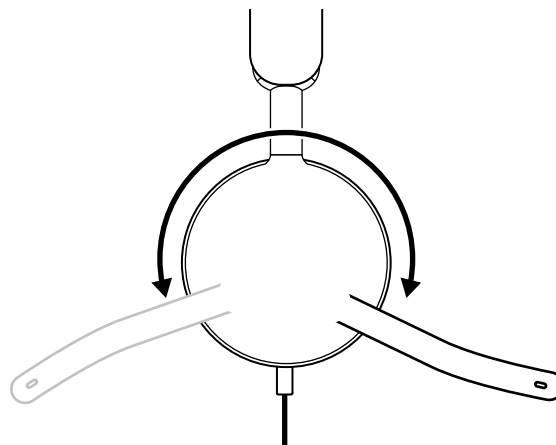

La tige de micro doit être placée à proximité ou à côté de votre bouche, alignée sur le coin de la bouche.

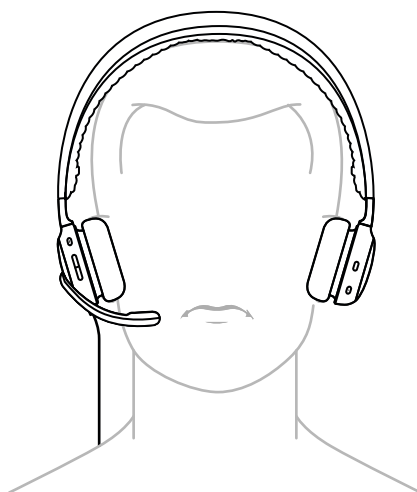

COMMANDES DU CASQUE

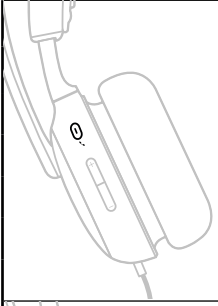
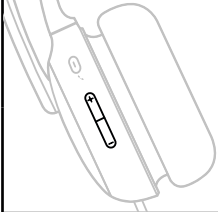
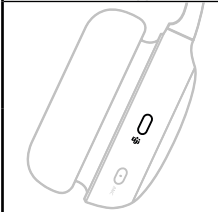
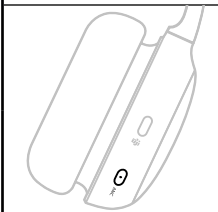
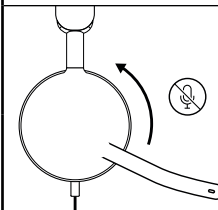
Bouton	Utilisation		Action
	Commandes d'appel¹	Réception/fin d'appel	Pression brève
		Terminer la réunion Teams	
		Reprendre un appel en attente	
	Commandes multimédia (Activer avec Logi Tune)	Rejeter un appel	Appuyez pendant 2 secondes
		Lecture/Pause	Pression brève
		Piste suivante	Double pression
	Piste précédente	Triple pression	
	Commandes de volume	Monter le volume	Pression brève sur « + »
		Baisser le volume	Pression brève sur « - »
	Commandes Teams (version Teams uniquement)	Activités Teams	Pression brève
	Contrôles ANC¹	Basculer entre ANC et Transparence activée	Pression brève
			ANC désactivée
	Couper le son	Son coupé	Relever la tige du micro
			Son réactivé

Remarque :

- Les activités Teams ne sont fonctionnelles que lorsque Teams fonctionne sur un PC ou un Mac déverrouillé. Pour en savoir plus sur le bouton Teams, consultez la page de support *Microsoft* : Utilisez le bouton *Microsoft Teams* sur votre dispositif Teams certifié.
- Des invitations vocales indiquent lorsque le micro est activé/désactivé.

SUPPRESSION DE L'ÉCHO (ANC)

L'ANC bloque le bruit autour de vous pour vous aider à vous concentrer sur la tâche à accomplir.

- Appuyez sur le bouton ANC sur le côté de l'oreillette pour basculer entre les modes ANC et transparence.
- Des invites vocales sont diffusées lorsque vous passez d'un mode à l'autre².

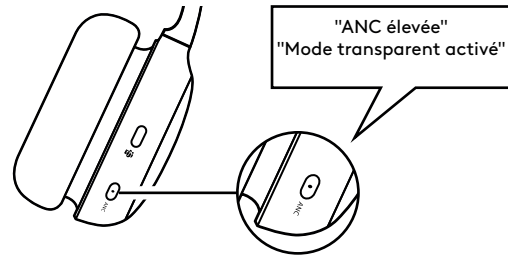

Remarque : le bouton ANC peut être personnalisé pour faire défiler jusqu'à 5 modes différents dans l'application Logi Tune.

TÉMOIN LUMINEUX DU CONNECTEUR

Légère		État
Blanc	Lumière continue	Réunion Teams active Appel en cours
	Clignotant	Appel entrant
Rouge	Lumière continue	Sourdine activée
Violet	Lumière continue	Connecté à Teams
	Clignotant	Connexion à Teams/ notifications Teams
Violet et blanc	Témoin clignotant	Mise à jour du micrologiciel du casque

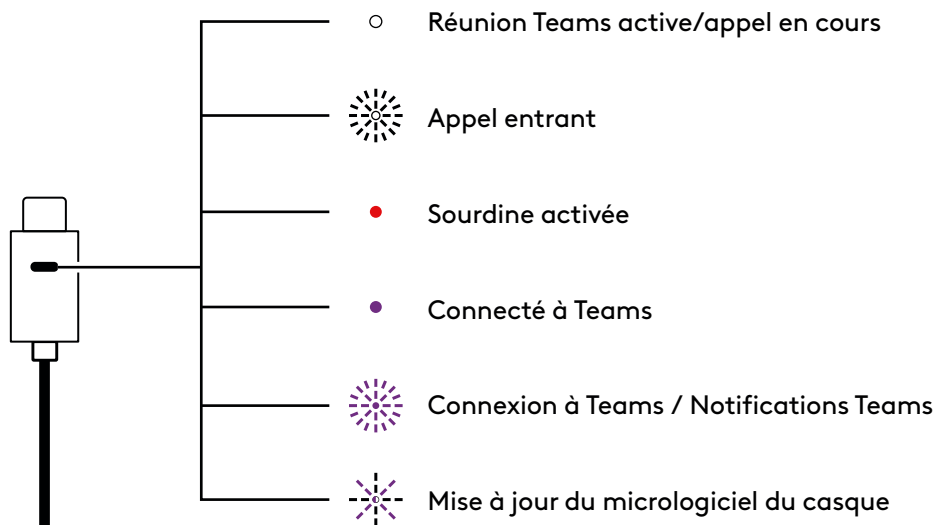

LOGI TUNE

Logi Tune vous aide à booster les performances de votre casque avec des mises à jour régulières du logiciel et du micrologiciel. Pour en savoir plus et télécharger Logi Tune : logitech.com/tune.



RÉGLAGE DE LA TONALITÉ

L'effet local vous permet d'entendre votre propre voix lorsque vous parlez pour que vous sachiez si vous parlez trop fort. Dans l'application Logi Tune, sélectionnez la fonctionnalité Effet local, mettez votre casque, puis ajustez le paramètre tout en parlant.

- Une valeur plus élevée signifie que vous entendrez plus de sons externes.
- Une valeur plus faible signifie que vous entendrez moins de sons externes.

ÉGALISEUR DE MICRO

Personnalisez l'égaliseur de micro dans Logi Tune pour ajuster votre voix afin qu'elle soit plus aiguë ou plus grave.

PROTECTION AUDITIVE

Zone Wired 2 for Business offre trois types de protection pour vous aider à entendre en toute sécurité.

Limitation des pics : le volume audio est toujours limité à 100 dBA pour éviter les dommages auditifs.

Protection contre les chocs acoustiques : cette protection limite les pics audio soudains pour éviter les chocs acoustiques conformément à la directive australienne G616. Cette fonctionnalité peut être activée dans l'application Logi Tune et s'applique uniquement aux activités d'appel.

Exposition au bruit dans le temps : cette fonctionnalité surveille les niveaux de bruit quotidiens moyens lors des appels pour ne pas dépasser la moyenne pondérée dans le temps de 85 dBA conformément à la directive australienne G616. Cette fonctionnalité peut être activée dans l'application Logi Tune et s'applique uniquement aux activités d'appel.

ACTIVATION DE L'ÉGALISEUR POUR LES APPELS

Logi Tune vous permet désormais d'appliquer des paramètres d'égaliseur pour les appels en plus de la musique. Personnalisez le son que vous entendez lors des appels avec des basses plus profondes, des aigus plus nets ou tout autre paramètre favori.

Activez l'option « Activer l'égaliseur pour les appels » dans Logi Tune pour utiliser vos paramètres d'égaliseur personnalisés pour les appels.

MODE D'ÉCONOMIE D'ÉNERGIE

Activez le mode d'économie d'énergie dans Logi Tune pour réduire l'utilisation d'énergie du dispositif auquel votre casque est connecté.

Lorsque la fonction est activée, le casque désactive automatiquement la suppression de bruit active (ANC) et le témoin lumineux après 30 minutes d'inactivité pour économiser de l'énergie.

Pour sortir le casque du mode veille, commencez simplement à l'utiliser en répondant à un appel, en écoutant de la musique ou en appuyant sur n'importe quel bouton.

MISE À JOUR DE VOTRE CASQUE

Nous vous recommandons de mettre à jour votre casque pour garantir des performances optimales.

Pour ce faire, téléchargez Logi Tune depuis logitech.com/tune et recherchez les mises à jour du micrologiciel disponibles.

DIMENSIONS

Casque :

Hauteur x largeur x profondeur :
185,2 x 183,6 x 73,0 mm

Poids :

223,5 g

Adaptateur :

Hauteur x Largeur x Épaisseur :
24,5 x 15,4 x 8,7 mm

CONFIGURATION REQUISE

Compatible avec la plupart des applications d'appels vidéo sur la majorité des plates-formes et systèmes d'exploitation. Compatible avec un ordinateur équipé de *Windows*, *Mac* ou *Chrome*³ via *USB-C* ou *USB-A*.

CARACTÉRISTIQUES TECHNIQUES

Type de microphone : 2 micros anti-parasite avec algorithme basé sur l'IA et égaliseur micro

Réponse en fréquence (casque) : 20 Hz - 20 kHz (mode Musique), 100 Hz - 8 kHz (mode Conversation)

Réponse en fréquence (microphone) : 100 Hz - 8 kHz

Longueur du câble : 1,9 m

Conformité audio : Conforme à la norme EN 50332-2

NOTE DE BAS DE PAGE

¹ Personnalisez le bouton dans Logi Tune. Vérifiez la compatibilité avec Logi Tune sur logi.com/tune.

² Le casque prend actuellement en charge les invites vocales dans les langues suivantes avec l'application de bureau Logi Tune : anglais, français, allemand et espagnol. Vous pouvez choisir votre langue préférée dans l'application.

³ Les fonctions de base du dispositif seront prises en charge pour les systèmes d'exploitation qui ne prennent pas en charge Logi Tune.

www.logitech.com/support/zonewired2b

COMPONENTES DEL PRODUCTO

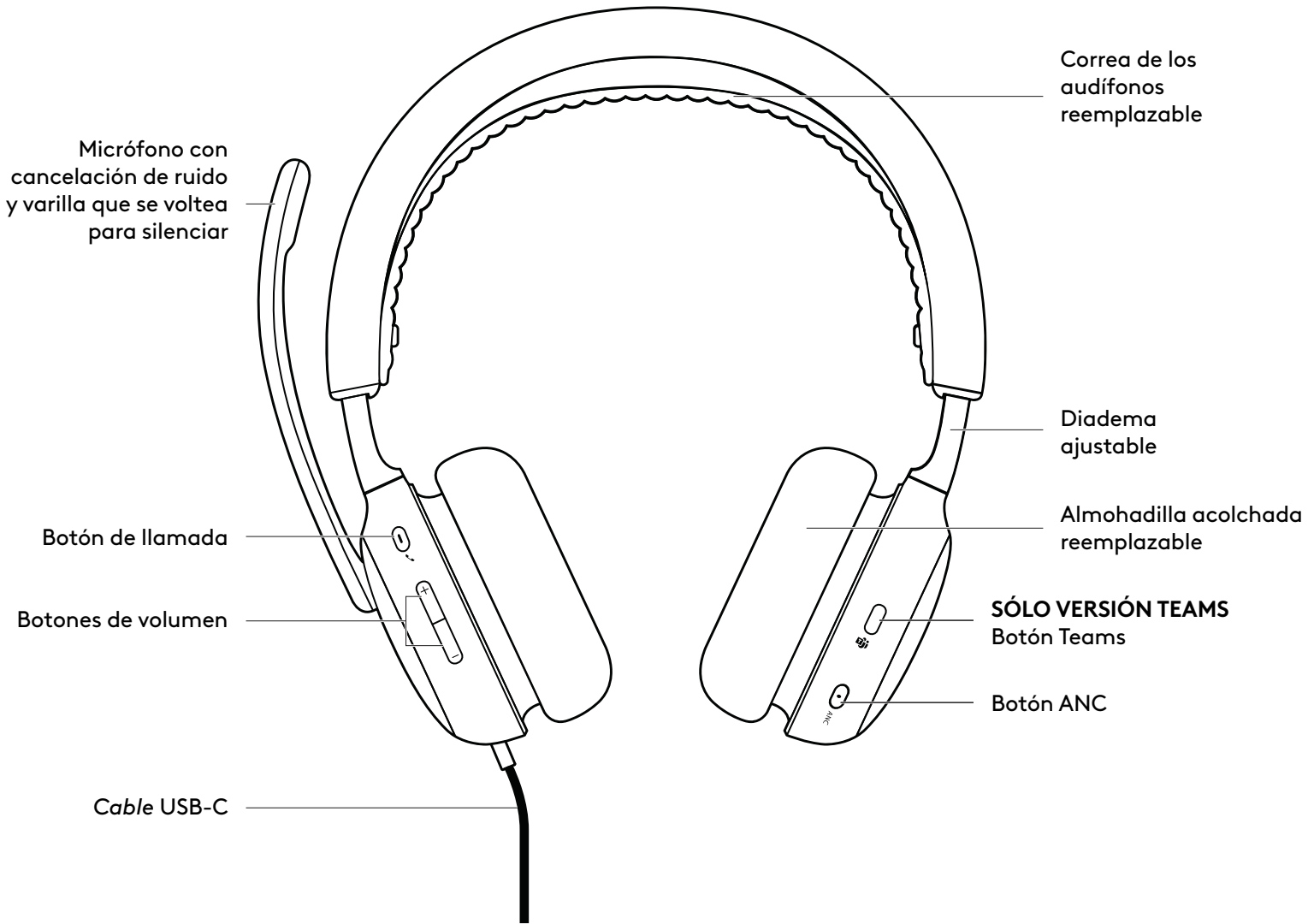

ADAPTADOR Y CONEXIÓN USB

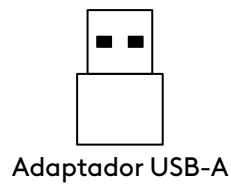
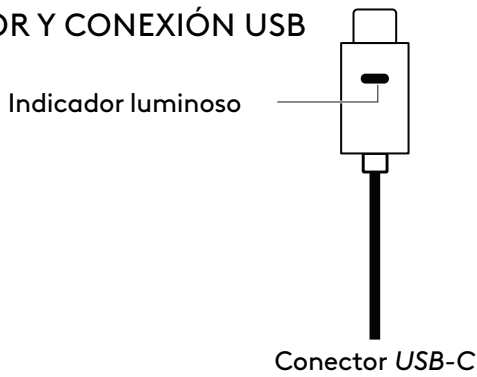

CONTENIDO DE LA CAJA

1. Audífonos
2. Adaptador USB-A
3. Bolsa de viaje
4. Documentación para el usuario

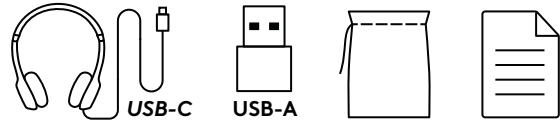

CONECTAR LOS AUDÍFONOS

Conecta el conector *USB-C* al puerto *USB-C* de la computadora. O usa el adaptador *USB-A* suministrado para conectar los auriculares al puerto *USB-A* de la computadora.

Nota: Solo usa el adaptador *USB-A* suministrado con los audífonos.

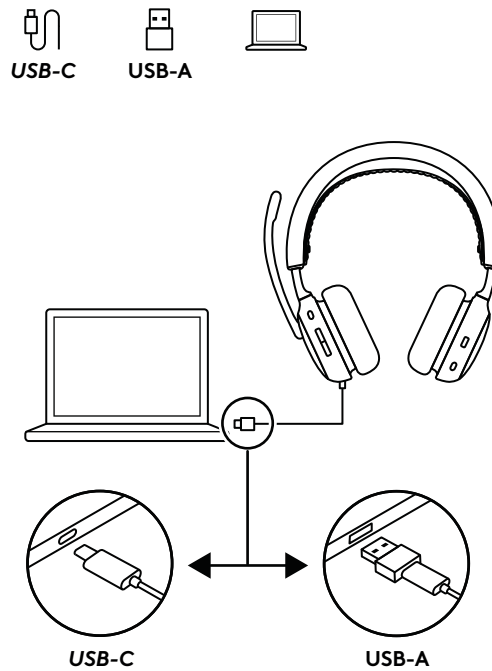

AJUSTAR LOS AUDÍFONOS

1. Ajusta los audífonos deslizando las copas hacia arriba o hacia abajo en la diadema.
2. Gira las copas para acomodarlas a las orejas.
3. Esta operación puede resultar más fácil si tienes los audífonos puestos. Mueve las copas hacia arriba y hacia abajo en la diadema hasta que las almohadillas cómodamente se asienten sobre las orejas.

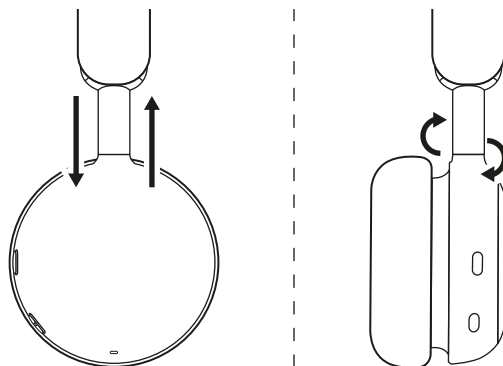

AJUSTAR LA VARILLA DEL MICRÓFONO

La varilla del micrófono gira 270 grados. Se puede colocar en el lado derecho o el izquierdo. El canal de audio cambiará automáticamente, dependiendo de la orientación del micrófono.

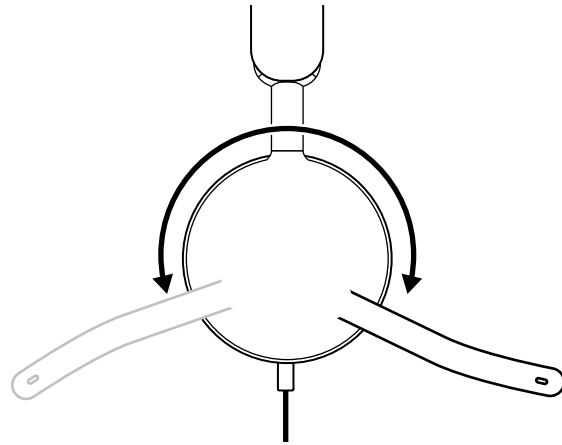

La varilla del micrófono debe colocarse cerca o al lado de la boca, alineada con la comisura de la boca.

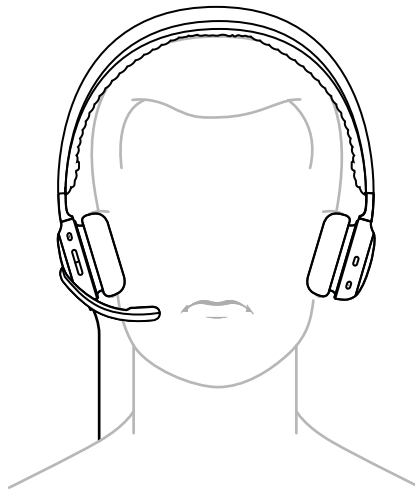

CONTROLES DE LOS AUDÍFONOS

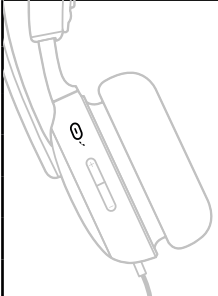
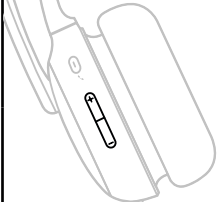
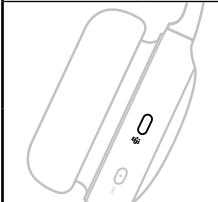
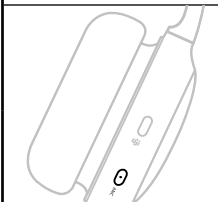
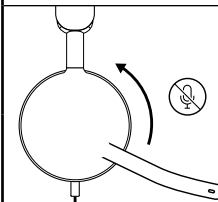
Botón	Uso		Acción
	Controles de llamadas ¹	Responder/Finalizar llamada	Pulsación corta
		Finalizar reunión de Teams	
		Reanudar llamada en espera	
	Controles multimedia (Habilitar con Logi Tune)	Rechazar llamada	Pulsación de 2 segundos
		Reproducir/Pausar	Pulsación corta
		Pista siguiente	Doble pulsación
		Pista anterior	Pulsación triple
	Controles de volumen	Subir volumen	Pulsación corta "+"
		Bajar volumen	Pulsación corta "-"
	Controles de Teams (Solo versión Teams)	Actividades de Teams	Pulsación corta
	Controles ANC ¹	Alternar entre ANC y Transparencia activada	Pulsación corta
			ANC desactivada
	Silencio	Silencio activado	Varilla de micrófono hacia arriba
			Silencio desactivado

Nota:

- Las actividades de Teams sólo funcionan cuando Teams se ejecuta en una PC o Mac desbloqueada. Para obtener más información sobre el botón de Teams, visita la página de asistencia de *Microsoft*: Usa el botón de *Microsoft Teams* en tu dispositivo Teams certificado.
- Los mensajes de voz indican cuando el micrófono está silenciado.

CANCELACIÓN ACTIVA DE RUIDO (ANC)

La función de cancelación bloquea el ruido del entorno para mejorar la concentración del usuario.

- Presiona el botón ANC en el lateral de la copa del audifono para alternar entre los modos ANC y Transparencia.
- Habrá mensajes de voz al cambiar de modo.²

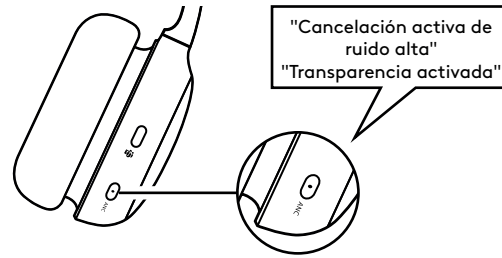

Nota: El botón ANC se puede personalizar para recorrer hasta 5 modos en la aplicación Logi Tune.

INDICADOR LUMINOSO DEL CONECTOR

Luz		Estado
Blanco	Permanente	Reunión de Teams activa Llamada en curso
	Destellos	Llamada entrante
Rojo	Permanente	Silencio activado
Morado	Permanente	Conexión a Teams
	Destellos	Conectando a Teams/ Notificaciones de Teams
Púrpura y blanco	Parpadeante	Actualización de firmware de los audífonos

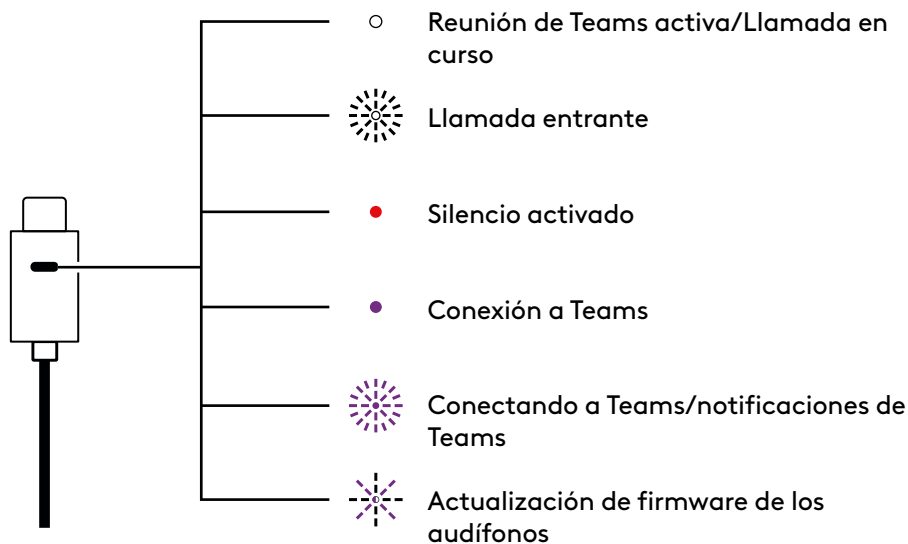

LOGI TUNE

Logi Tune optimiza el desempeño de los audífonos con actualizaciones periódicas de software y firmware. Conoce más y descarga Logi Tune en logitech.com/tune.



AJUSTAR EL TONO LATERAL

El tono lateral permite escuchar la propia voz durante las conversaciones, para comprobar el volumen de voz utilizado. En la aplicación Logi Tune, selecciona la función de tono lateral, ponte los audífonos y ajusta la configuración mientras hablas.

- Un número alto significa que se escuchará más sonido externo.
- Un número bajo significa que se escuchará menos sonido externo.

ECUALIZADOR DE MICRÓFONO

Personaliza el ecualizador de micrófono en Logi Tune para ajustar tu voz para que suene más alegre o más profunda.

PROTECCIÓN AUDITIVA

Zone Wired 2 ES for Business proporciona tres tipos de protección para que oigas sin riesgos para tu salud.

Límite máximo: el volumen de audio siempre está limitado a 100 dBA para evitar el daño auditivo.

Protección contra sobresaltos: elimina los picos de audio repentinos para evitar golpes acústicos, conforme a la directriz australiana G616. Esto se puede activar en la aplicación Logi Tune y sólo se aplica a actividades de llamadas.

Exposición prolongada al ruido: supervisa los niveles de ruido promedio diarios en las llamadas para que no superen el promedio ponderado en el tiempo de 85 dBA según la directriz australiana G616. Esto se puede activar en la aplicación Logi Tune y sólo se aplica a actividades de llamadas.

HABILITA EL ECUALIZADOR PARA LLAMADAS

Logi Tune ahora te permite aplicar la configuración del ecualizador al audio de las llamadas además de a la música. Personaliza el sonido que escuchas en las llamadas con graves más profundos, agudos más nítidos o cualquier otra configuración que prefieras.

Activa la opción "Habilitar el ecualizador para llamadas" en Logi Tune para usar tu configuración de ecualizador personalizada para las llamadas.

MODO DE AHORRO DE ENERGÍA

Activa el modo de ahorro de energía en Logi Tune para reducir el consumo de energía del dispositivo al que están conectados los audífonos.

Cuando está activado, los auriculares apagarán automáticamente la supresión activa de ruido (ANC) y el indicador luminoso después de 30 minutos de inactividad para ahorrar energía.

Para activar los audífonos, simplemente comienza a usarlos uniéndote a una llamada, escuchando música o presionando cualquier botón.

ACTUALIZAR LOS AUDÍFONOS

Recomendamos actualizar los auriculares para garantizar un rendimiento óptimo. Para hacerlo, descarga Logi Tune desde logitech.com/tune y comprueba si hay actualizaciones de firmware disponibles.

DIMENSIONES

Audífonos:

Altura x Ancho x Profundidad:
185,2 x 183,6 x 73,0 mm

Peso:

223,5 g

Adaptador:

Altura x Ancho x Profundidad:
24,5 x 15,4 x 8,7 mm

REQUISITOS DEL SISTEMA

Funcionan con las principales aplicaciones de llamadas en casi todas las plataformas y sistemas operativos. Funciona con computadoras con *Windows*, *Mac* o *Chrome*³ por *USB-C* o *USB-A*.

ESPECIFICACIONES TÉCNICAS

Tipo de micrófono: 2 micrófonos con cancelación de ruido, algoritmos basados en IA y ecualizador de micrófono

Respuesta de frecuencia (audífonos con micrófono): 20 Hz - 20 kHz (modo música), 100 Hz - 8 kHz (modo conversación)

Respuesta de frecuencia (micrófono): 100 Hz - 8 kHz

Longitud del cable: 1.9 m

Cumplimiento de las normativas de audio: Cumple con la normativa EN 50332-2

NOTA AL PIE DE PÁGINA

¹ Personaliza el botón en Logi Tune. Comprueba la compatibilidad de Logi Tune en logi.com/tune.

² Actualmente, los auriculares admiten mensajes de voz en los siguientes idiomas con la aplicación Logi Tune para escritorio: Inglés, francés, alemán y español. Puedes elegir tu idioma preferido en la aplicación.

³ Las funciones básicas del dispositivo serán compatibles con sistemas operativos que no admitan Logi Tune.

www.logitech.com/support/zonewired2b

CONHECER O PRODUTO

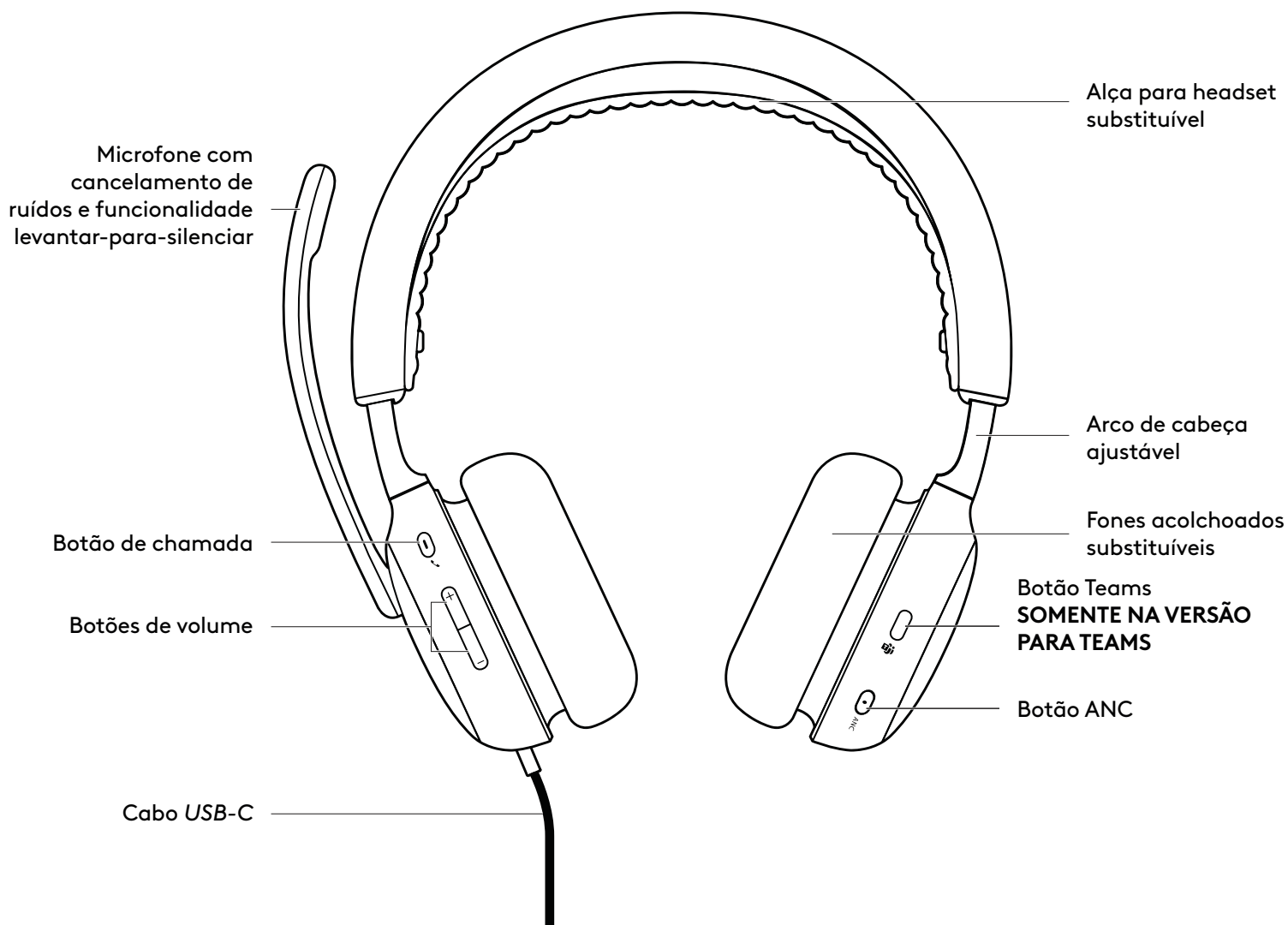

PLUG USB E ADAPTADOR

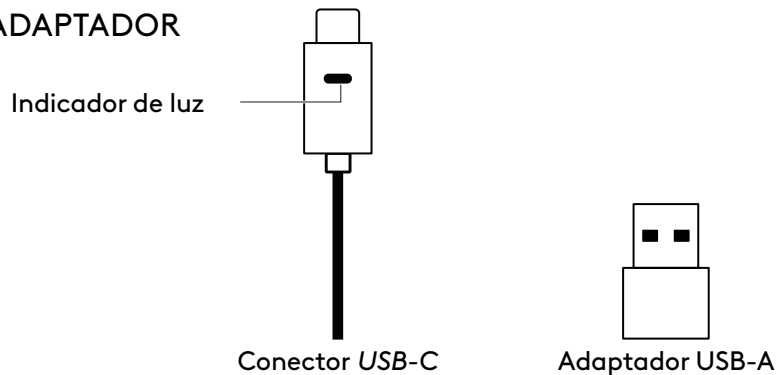

CONTEÚDO DA EMBALAGEM

1. Headset
2. Adaptador USB-A
3. Bolsa para transporte
4. Documentação para o usuário

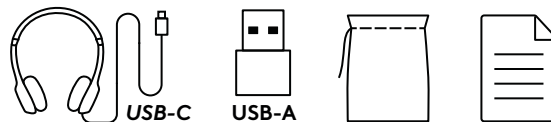

CONECTE SEU HEADSET

Conecte o conector *USB-C* à porta *USB-C* do computador. Ou use o adaptador *USB-A* fornecido para conectar o headset à porta *USB-A* do computador.

Observação: use apenas o adaptador *USB-A* com o headset fornecido.

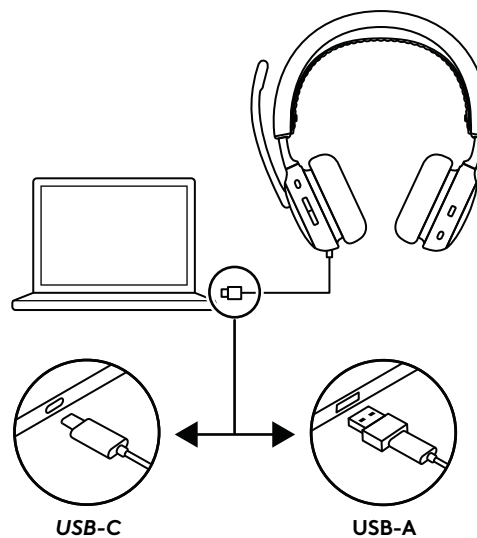

AJUSTE DO HEADSET

1. Ajuste o headset deslizando os fones de ouvido para cima e para baixo no arco de cabeça.
2. Fones giratórios para encaixar no ouvido.
3. Pode ser mais fácil ajustar o fone de ouvido na cabeça. Mova os fones de ouvido para cima e para baixo no arco de cabeça até que eles se acomodem confortavelmente em seus ouvidos.

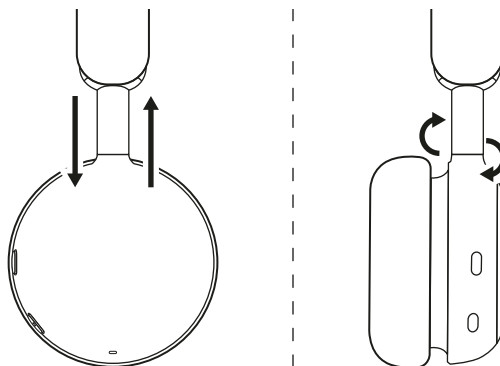

AJUSTE O BRAÇO DO MICROFONE

O braço do microfone gira 270 graus. Use-o no lado esquerdo ou direito. O canal de áudio mudará automaticamente, dependendo da direção em que você estiver usando o microfone.

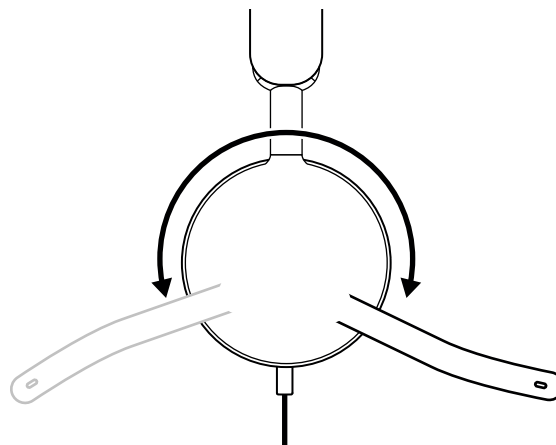

A haste do microfone deve ser colocada perto ou ao lado da boca, alinhada com o canto dela.

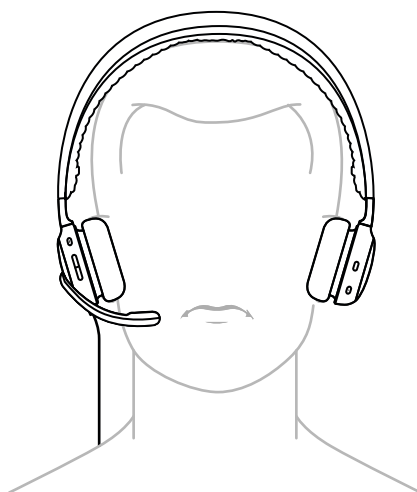

CONTROLES NO HEADSET

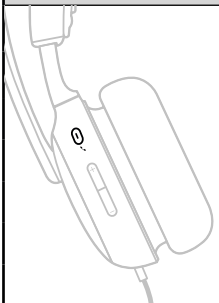
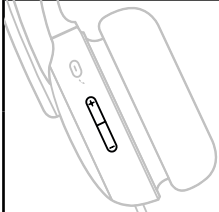
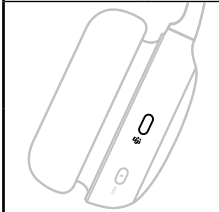
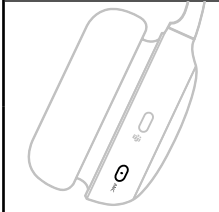
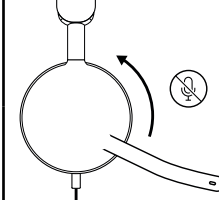
Botão	Uso		Ação
	Controles de chamada ¹	Atender/Encerrar ligação	Pressione por tempo curto
		Encerrar reunião no Teams	
		Retomar chamada em espera	
	Controles de mídia (Ative com o Logi Tune)	Rejeitar chamada	Pressione por 2 segundos
		Reproduzir/pausar	Pressione por tempo curto
		Próxima faixa	Pressionamento duplo
	Faixa anterior	Pressionamento triplo	
	Controles de volume	Mais volume	Pressione brevemente "+"
		Menos volume	Pressione brevemente "-"
	Controles do Teams (apenas para a versão do Teams)	Atividades do Teams	Pressione brevemente
	Controles ANC ¹	Alternar entre ANC e Transparência ligada	Pressione por tempo curto
			ANC desativado
	Sem som	Silêncio ativado	Braço do microfone levantado
			Silêncio desativado

Observação:

- As atividades do Teams são funcionais apenas quando o Teams estiver sendo executado em um PC ou Mac desbloqueado. Para saber mais sobre o botão Teams, visite a página de suporte da *Microsoft*: Use o botão *Microsoft Teams* em seu dispositivo certificado para o Teams.
- As notificações por voz indicam quando o microfone está ligado/desligado.

CANCELAMENTO DE RUÍDO ATIVO (ANC)

O ANC bloqueia o ruído ao seu redor para ajudá-lo a se concentrar no trabalho.

- Pressione o botão ANC na lateral do fone para alternar entre os modos ANC e transparência.
- Haverá notificações por voz ao alternar entre os modos.²

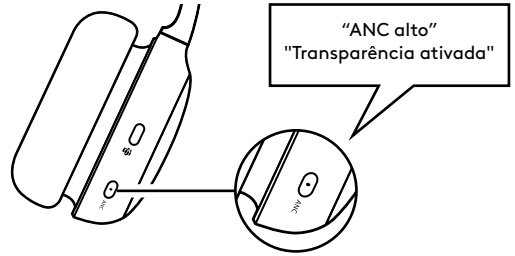

Observação: o botão ANC pode ser personalizado para alternar entre até cinco modos diferentes no aplicativo Logi Tune.

LUZ INDICADORA DO CONECTOR

Luz		Status
Branco	Estável	Reunião ativa no Teams Chamada em andamento
	Piscando	Chamada recebida
Vermelho	Estável	Sem áudio ativado
Roxo	Estável	Conectado ao Teams
	Brilhando	Conectando-se ao Teams / Notificações do Teams
Roxo e branco	Piscando	Atualização do firmware do headset

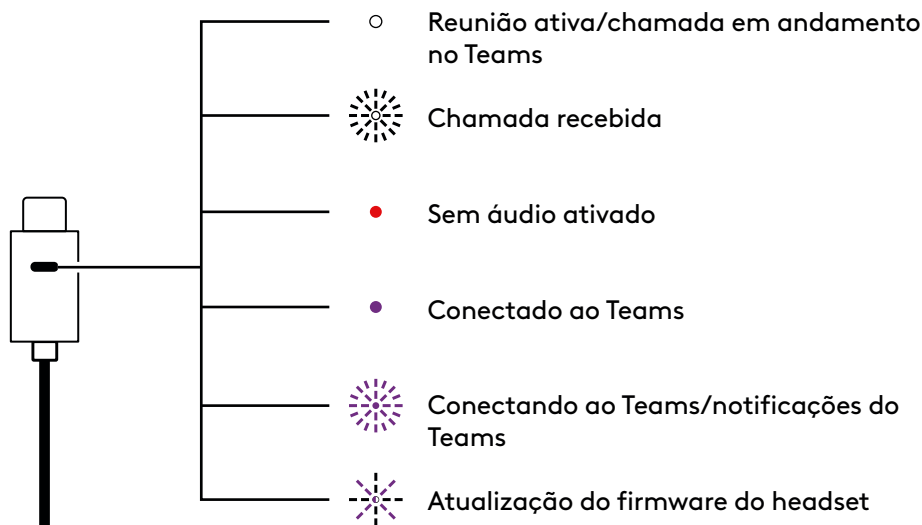

LOGI TUNE

O Logi Tune ajuda a aumentar o desempenho do headset com atualizações periódicas de software e de firmware. Saiba mais e faça download do Logi Tune em logitech.com/tune.



AJUSTE DO SIDETONE

O **Sidetone** permite que você ouça sua própria voz ao falar, assim você fica ciente de quão alto está falando. No aplicativo Logi Tune, selecione o recurso sidetone, coloque seu headset e ajuste a configuração enquanto fala.

- Um número maior significa que você ouve mais som externo.
- Um número menor significa que você ouve menos som externo.

EQUALIZADOR DE MICROFONE

Personalize o equalizador do microfone no Logi Tune para ajustar sua voz e ela soar mais clara ou profunda.

PROTEÇÃO AUDITIVA

O Zone Wired 2 for Business oferece três tipos de proteção para ajudar você a ouvir com segurança.

Limitação de pico: o volume do áudio é sempre limitado a 100 dBA para evitar danos auditivos.

Proteção contra choques acústicos: elimina picos de áudio repentinos para evitar choques acústicos de acordo com a diretriz australiana G616. Isso pode ser ativado no aplicativo Logi Tune e se aplica apenas a atividades de chamadas.

Exposição a ruídos ao longo do tempo: esse recurso monitora os níveis médios diários de ruído em chamadas para não ultrapassar a média ponderada por tempo de 85 dBA, de acordo com a diretriz australiana G616. Isso pode ser ativado no aplicativo Logi Tune e se aplica apenas a atividades de chamadas.

ATIVAR EQUILIZADOR PARA CHAMADAS

Agora o Logi Tune permite aplicar as configurações do equalizador para o áudio de chamadas, além da música. Personalize o som que você ouve em chamadas com graves mais profundos, agudos mais nítidos ou outra configuração de sua preferência.

Ative o botão "Ativar equalizador para chamadas" no Logi Tune para usar as configurações personalizadas do equalizador para chamadas.

MODO DE ECONOMIA DE ENERGIA

Ative o modo de economia de energia no Logi Tune para reduzir o uso de energia do dispositivo ao qual o headset está conectado.

Quando ativado, o headset desligará automaticamente o cancelamento de ruído ativo (ANC) e a luz indicadora após 30 minutos de inatividade para economizar energia.

Para ativar o headset, basta começar a usá-lo em uma chamada, ouvindo música ou pressionando qualquer botão.

ATUALIZAR O HEADSET

Recomendamos atualizar seu headset para garantir um desempenho ideal.

Para fazer isso, baixe o Logi Tune em logitech.com/tune e verifique se há atualizações de firmware disponíveis.

DIMENSÕES

Headset:

Altura x largura x profundidade:
185,2 x 183,6 x 73,0 mm

Peso:

223,5 g

Adaptador:

Altura x largura x profundidade:
24,5 x 15,4 x 8,7 mm

REQUISITOS DE SISTEMA

Compatível com aplicativos de chamada comuns em quase todas as plataformas e sistemas operacionais. Compatível com computadores *Windows*, *Mac* ou *Chrome*³ via *USB-C* ou *USB-A*.

ESPECIFICAÇÕES TÉCNICAS

Tipo de microfone: dois microfones com cancelamento de ruídos, algoritmos otimizados por IA e equalizador de microfone

Resposta de frequência (headset): 20 Hz a 20 kHz (modo de música),
100 Hz a 8 kHz (modo de conversa)

Resposta de frequência (microfone): 100 Hz a 8 kHz

Comprimento do cabo: 1,9 m

Conformidade de áudio: Em conformidade com a norma EN 50332-2

NOTA DE RODAPÉ

- ¹ Personalize o botão no Logi Tune. Verifique a compatibilidade do Logi Tune em logi.com/tune.
- ² O headset atualmente é compatível com notificações por voz nos seguintes idiomas com o aplicativo Logi Tune para desktop: inglês, francês, alemão e espanhol. No aplicativo, é possível escolher o idioma de sua preferência.
- ³ As funções básicas do dispositivo serão suportadas em sistemas operacionais que não são compatíveis o Logi Tune.

www.logitech.com/support/zonewired2b

瞭解您的產品

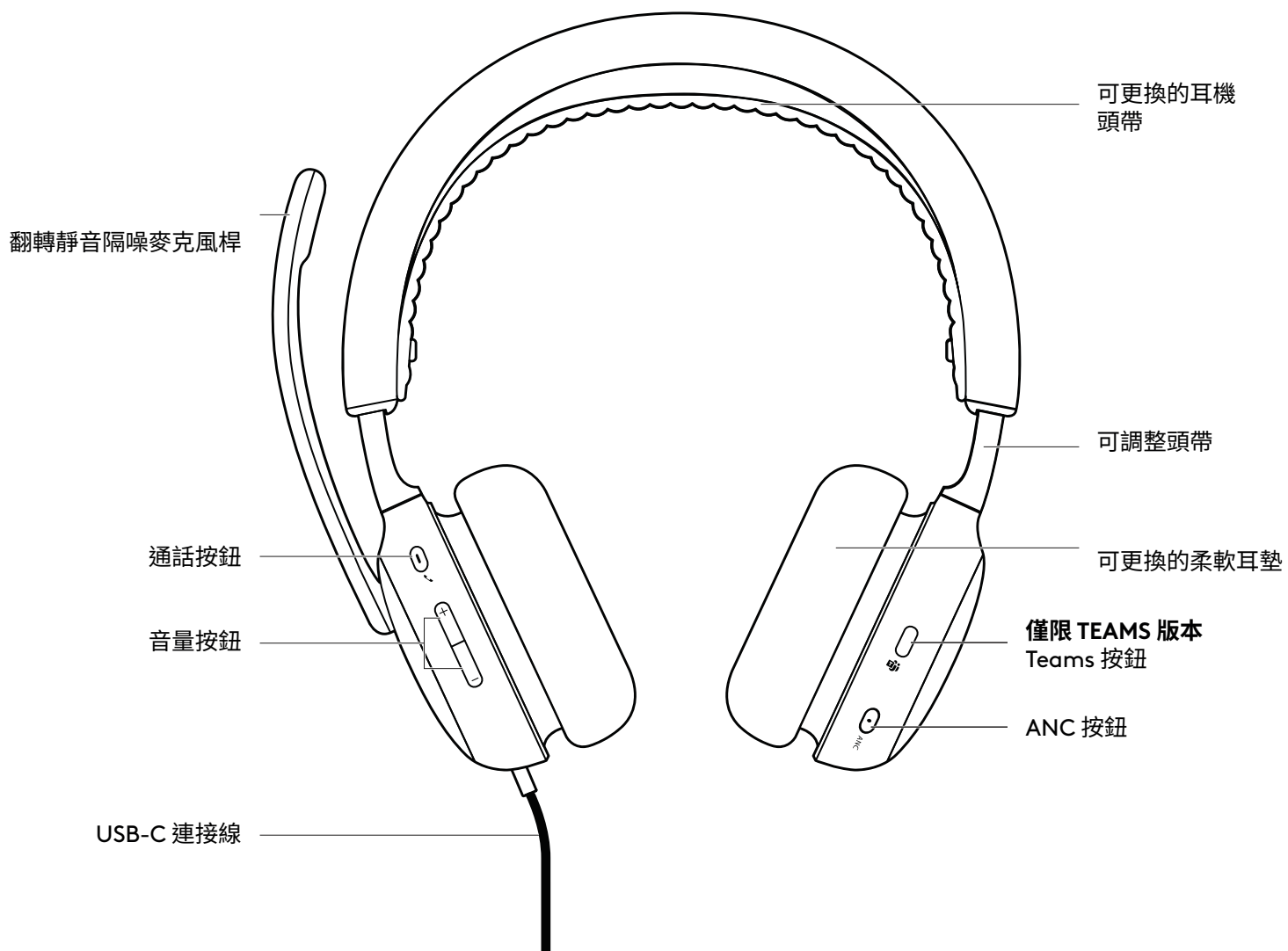

USB 插頭與轉接器

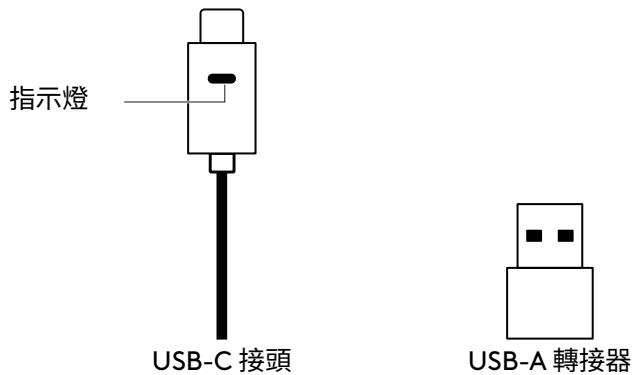

包裝內容

1. 耳機
2. USB-A 轉接器
3. 攜行袋
4. 使用者文件

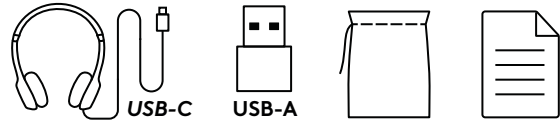

連線耳機

將 USB-C 接頭插入電腦的 USB-C 連接埠。或是使用隨附的 USB-A 轉接器，將耳機插入電腦的 USB-A 連接埠。

注意：請僅使用 USB-A 轉接器搭配隨附的耳機。

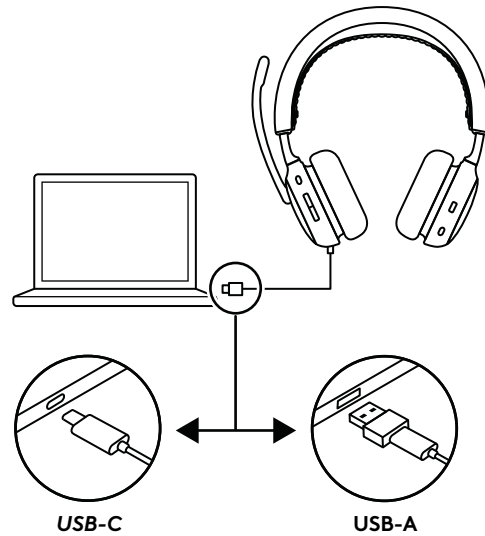

調整耳機

1. 耳機的調整是透過在頭帶上下滑動耳罩來進行。
2. 旋轉耳罩以配合您的耳朵。
3. 可輕鬆調整耳機麥克風配戴在頭部的位置。將耳罩於頭帶上下滑動，直到其舒適的戴在您的耳朵上。

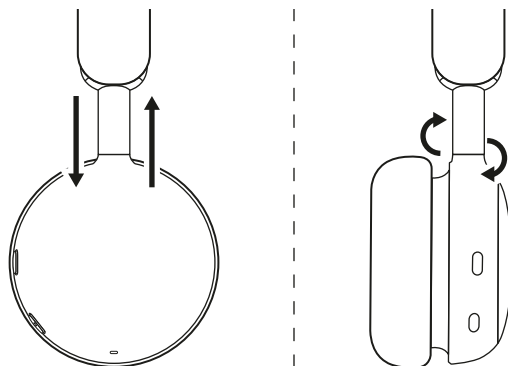

調整麥克風桿

麥克風桿可旋轉 270 度。將其配戴在左側或右側。音訊頻道會視您配戴麥克風的方向自動切換。

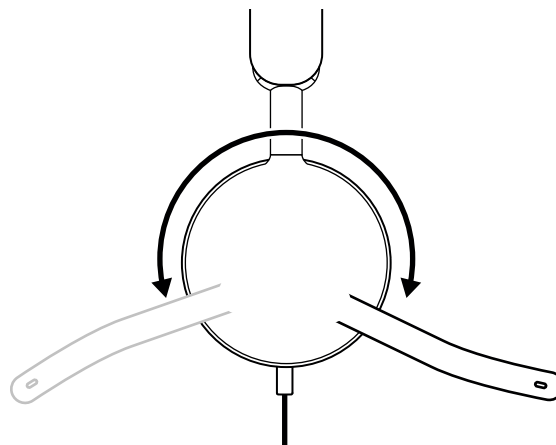

麥克風桿應放置在靠近或貼近您嘴巴的位置，並與嘴角對齊。



耳機控制按鈕

按鈕	用途		動作
	通話控制 ¹	接聽/掛斷通話	短按
		結束 Teams 會議	
		恢復保留中的通話	
	媒體控制 (透過 Logi Tune 啟用)	拒絕通話	按住 2 秒
		播放/暫停	短按
		下一曲目	按兩下
	上一曲目	按三下	
	音量控制	提高音量	短按「+」
		調低音量	短按「-」
	Teams 控制 (僅限 Teams 版本)	Teams 活動	短按
			按住 2 秒
	ANC 控制 ¹	在 ANC 和 「穿透模式開啟」之間切換	短按
		ANC 關閉	按住 2 秒
	靜音	靜音開啟	將麥克風桿往上翻
		靜音關閉	將麥克風桿往下翻

注意：

- Teams 活動僅在 Teams 正在未鎖定的 PC 或 Mac 上執行時可以使用。若要了解更多關於 Teams 按鈕的資訊，請造訪 [Microsoft 支援頁面](#)：請在您獲得認證的 Teams 裝置，使用 Microsoft Teams 按鈕。
- 語音提示會在麥克風靜音開啟/關閉時告知狀態。

主動隔噪 (ANC)

ANC 會阻隔您周圍的噪音，以協助您專心在手邊的工作上。

- 按下耳罩側邊的 ANC 按鈕可切換 ANC 和穿透模式。
- 在模式間切換時，會有語音提示告知狀態。²

注意：ANC 按鈕可以在 Logi Tune 應用程式中自訂為在 5 種不同的模式間循環切換。

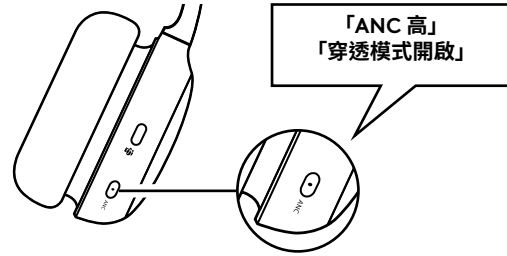

接頭指示燈

輕		狀態
白燈	穩定亮起	進行中的 Teams 會議 通話中
	閃爍	來電
紅燈	穩定亮起	靜音開啟
紫燈	穩定亮起	已連線到 Teams
	閃爍	正在連線到 Teams / Teams 通知
紫燈與白燈	閃爍	耳機正在更新韌體

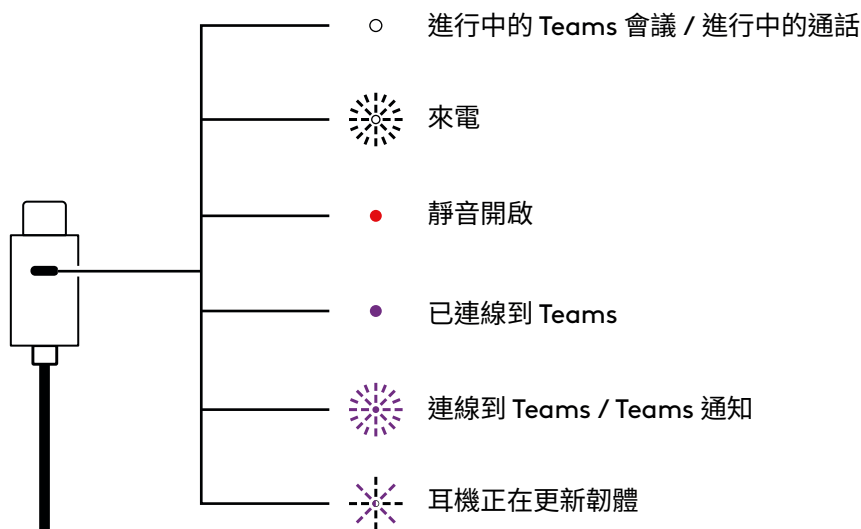

LOGI TUNE

Logi Tune 可透過定期的軟體與韌體更新，協助加強耳機性能。如需更多資訊並下載 Logi Tune，請到：logitech.com/tune。



調整側音

側音可讓您在說話時聽到自己的聲音，以便您能知道自己說話的音量大小。在 Logi Tune 應用程式中，選取側音功能，戴上耳機，並在說話時調整設定。

- 數值較高表示您會聽到較多的外部聲音。
- 數值較低表示您會聽到較少的外部聲音。

麥克風等化器

在 Logi Tune 中自訂麥克風等化器，將您的聲音調整得更明亮或更低沉。

聽力保護

Zone Wired 2 for Business 提供三種類型的保護，能幫助您安全地聆聽。

峰值限制：音訊音量始終限制在 100dBA 以下，以防止聽力受損。

防驚嚇保護：根據澳洲 G616 規範，此功能可限制突然的音訊突波，以避免聲學衝擊。此功能可在 Logi Tune 應用程式中啟用，且僅適用於通話活動。

時段中的噪音暴露：此功能會監控通話中的每日平均噪音等級，確保不超過澳洲 G616 規範所定的 85dBA 時間加權平均值。此功能可在 Logi Tune 應用程式中啟用，且僅適用於通話活動。

為通話啟用等化器

除了音樂，Logi Tune 現在也可讓您將等化器設定套用至通話音訊。使用更深沉的低音、更清脆的高音或任何其他偏好的設定，自訂您在通話中聽到的聲音。

在 Logi Tune 中開啟「為通話啟用等化器」的切換開關，即可在通話中使用您自訂的等化器設定。

省電模式

在 Logi Tune 中啟動省電模式，以降低耳機所連線裝置的耗電量。

啟用後，耳機在閒置 30 分鐘後將自動關閉主動降噪 (ANC) 和指示燈，以節省電力。

若要喚醒耳機，只需開始使用它即可，例如加入通話、聆聽音樂或按下任何按鈕。

更新耳機

我們建議您更新耳機，以確保獲得最佳效能。

若要這麼做，請前往 logitech.com/tune 下載 Logi Tune，然後檢查是否有可用的韌體更新。

尺寸

耳機：

高 x 寬 x 深：

185.2 x 183.6 x 73.0 公釐

重量：

223.5 公克

轉接器：

高 x 寬 x 深：

24.5 x 15.4 x 8.7 公釐

系統需求

可搭配幾乎所有平台和作業系統上的常見通話應用程式使用。可透過 USB-C 或 USB-A 搭配 Windows、Mac 或 Chrome 電腦³ 使用。

技術規格

麥克風類型：2 個具備 AI 演算法和麥克風 EQ 的降噪麥克風

耳機頻率響應：20 Hz – 20 kHz (音樂模式)，100 Hz – 8 kHz (通話模式)

麥克風頻率響應：100 Hz – 8 kHz

連接線長度：1.9 公尺

音訊合規性：EN 50332-2 合規

註腳

- ¹ 在 Logi Tune 中可自訂按鈕。請至 logitech.com/tune 查看 Logi Tune 相容性。
- ² 此耳機目前在 Logi Tune 桌面應用程式中支援下列語言的語音提示：英文、法文、德文和西班牙文。您可以在應用程式中選擇偏好使用的語言。
- ³ 在不支援 Logi Tune 的作業系統上，可支援裝置基本功能。

www.logitech.com/support/zonewired2b

제품 설명

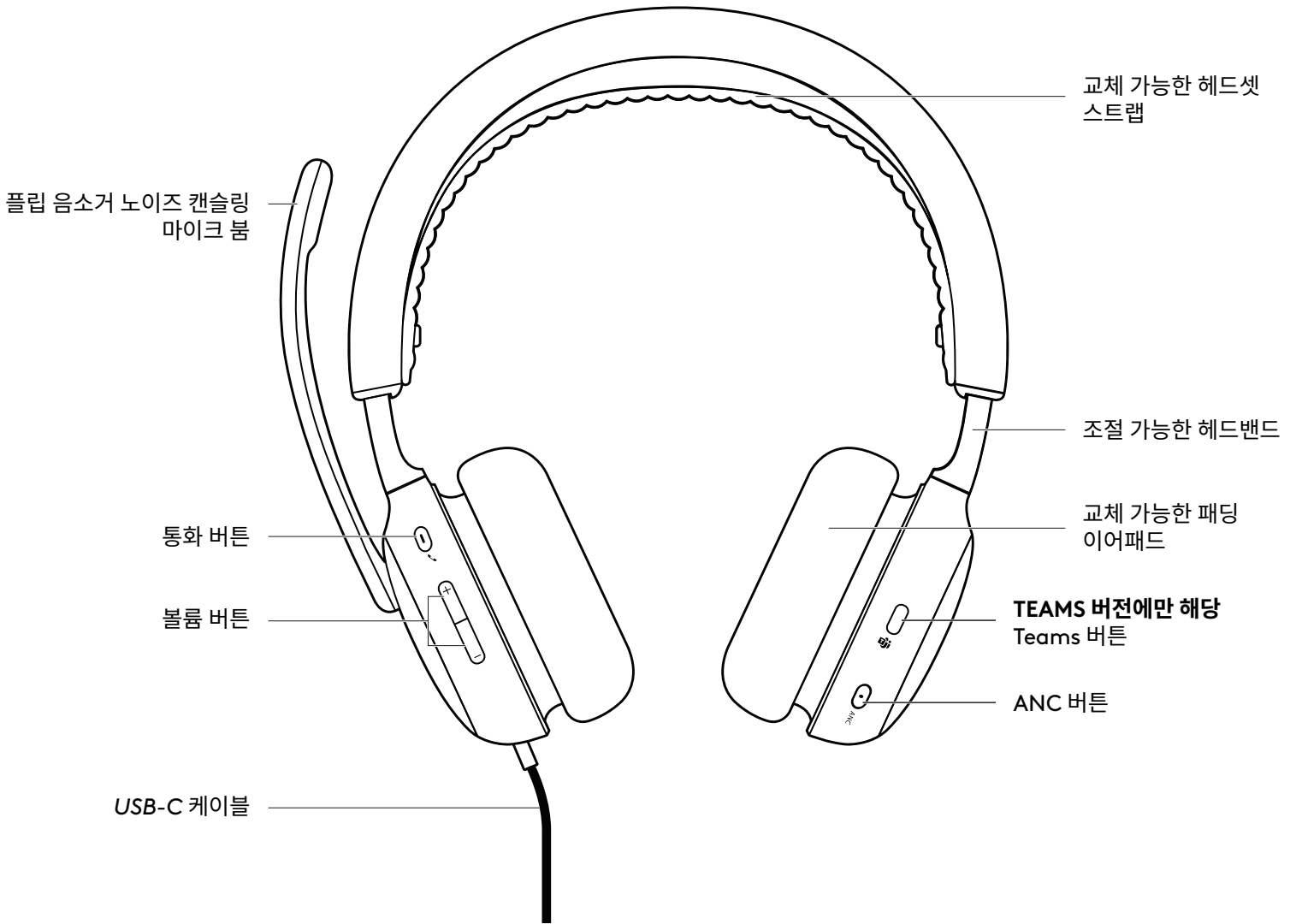

USB 플러그 및 어댑터

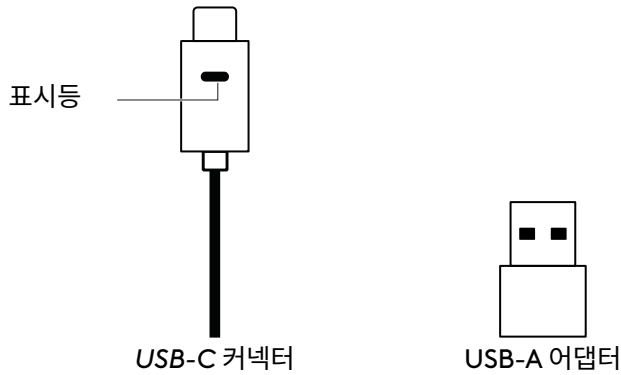

내용물

1. 헤드셋
2. USB-A 어댑터
3. 휴대용 가방
4. 사용 설명서

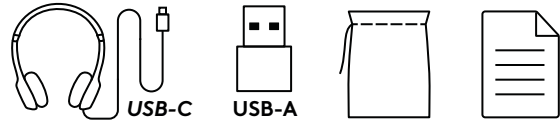

헤드셋 연결하기

USB-C 커넥터를 컴퓨터의 USB-C 포트에 연결합니다. 또는 제공된 USB-A 어댑터를 사용하여 헤드셋을 컴퓨터의 USB-A 포트에 연결합니다.

참고: 제공된 헤드셋에는 USB-A 어댑터만 사용하십시오.

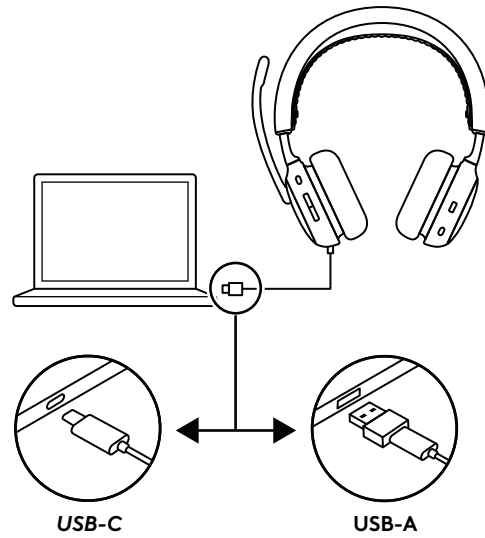

헤드셋 조절

1. 헤드밴드의 이어컵을 위아래로 밀어서 헤드셋을 조절합니다.
2. 이어컵을 귀에 맞게 돌립니다.
3. 머리에 쓴 채로 조절하면 더 간편한 조절이 가능합니다. 이어컵이 귀에 편안하게 안착될 때까지 헤드밴드를 위아래로 움직여 줍니다.

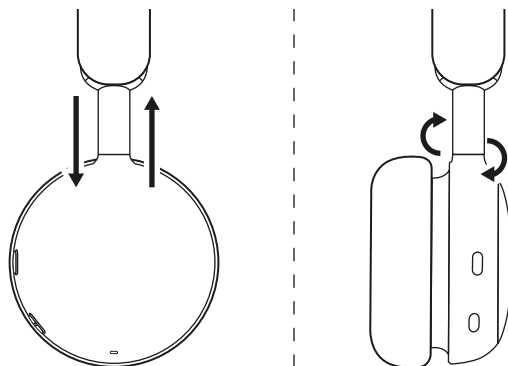

마이크 붐 조절

마이크 붐은 270도 회전 가능합니다. 왼쪽 또는 오른쪽에 착용할 수 있습니다. 마이크 착용 방향에 따라 오디오 채널이 자동으로 전환됩니다.

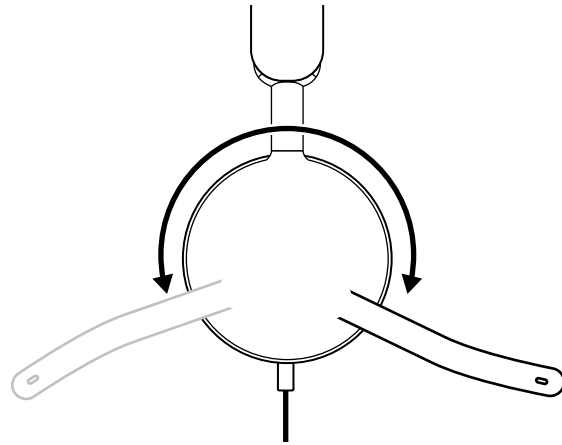

마이크 붐은 입에 가까이 또는 옆에 두어 입 가장자리와 일직선이 되도록 해야 합니다.

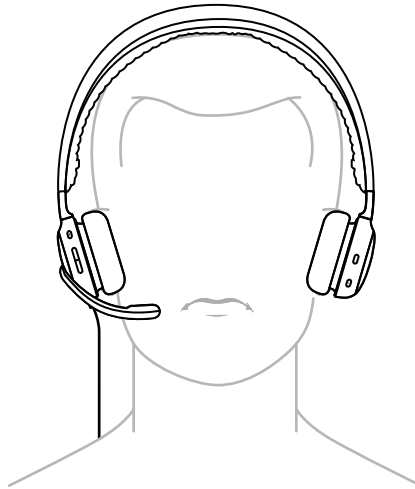

헤드셋 컨트롤

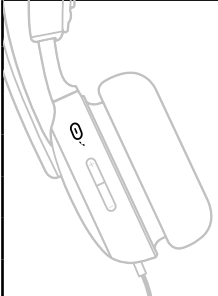
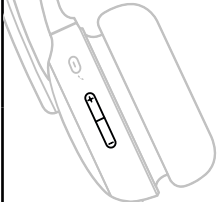
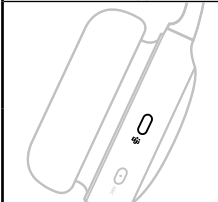
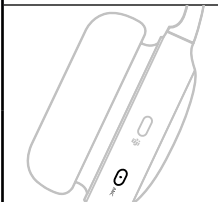
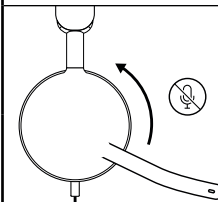
단추	용도		조치
	통화 컨트롤 ¹	응답 / 통화 종료	짧은 누르기
		Teams 회의 종료	
		대기 중인 통화 재개	
	미디어 컨트롤 (Logi Tune으로 활성화)	통화 거절	2초 누르기
		재생 / 일시 중지	짧은 누르기
		다음 트랙	두 번 누르기
이전 트랙	세 번 누르기		
	볼륨 높이기	"+" 짧게 누르기	
	볼륨 줄이기	"-" 짧게 누르기	
	Teams 컨트롤 (Teams 버전에만 해당)	Teams 활동	짧게 누르기
		2초 누르기	
	ANC 컨트롤 ¹	ANC 및 투명 모드 간에 전환	짧은 누르기
		ANC 꺼짐	2초 누르기
	음소거	음소거 켜짐	마이크 볼을 위로 올리기
		음소거 꺼짐	마이크 볼을 아래로 내리기

참고:

- Teams 활동은 PC 또는 Mac이 잠겨 있지 않고 Teams가 실행 중일 때만 작동합니다. Teams 버튼에 대한 자세한 내용은, Microsoft 지원 페이지를 참조하십시오. 인증된 Teams 장치에서 Microsoft Teams 버튼을 사용할 수 있습니다.
- 음성 알림이 마이크 음소거 켜짐/꺼짐 상태를 알려줍니다.

액티브 노이즈 캔슬링(ANC)

ANC는 작업에 집중할 수 있도록 주변 소음을 차단합니다.

- 이어컵 측면에 있는 ANC 버튼을 눌러 ANC와 투명 모드 사이를 전환할 수 있습니다.
- 모드 전환 시 음성으로 알려줍니다.?

참고: Logi Tune 앱에서 ANC 버튼이 최대 5개의 모드 사이를 순환하도록 설정할 수 있습니다.

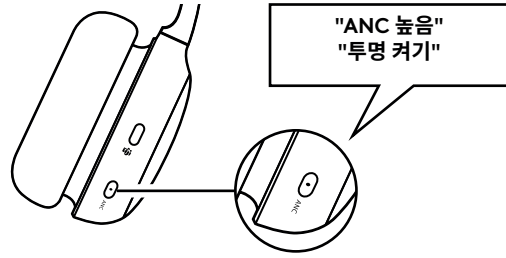

커넥터 표시등

표시등		상태
흰색	계속 켜짐	Teams 회의 활성화 통화 중
	깜박임	걸려온 통화
빨간색	계속 켜짐	음소거 켜짐
자주색	계속 켜짐	Teams 연결됨
	깜박임	Teams 연결 / Teams 알림
보라색 및 흰색	깜박임	헤드셋 펌웨어 업데이트 중

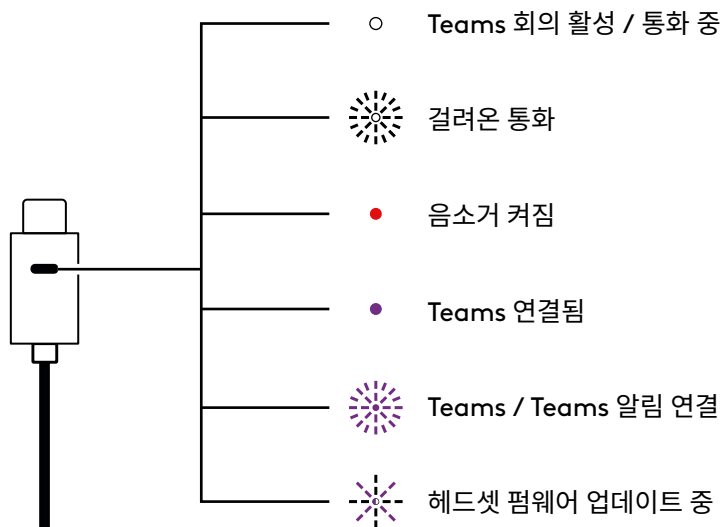

LOGI TUNE

Logi Tune은 정기 소프트웨어 및 펌웨어 업데이트로 헤드셋 성능 향상을 지원합니다. logitech.com/tune에서 Logi Tune에 대해 자세히 알아보고 다운로드하세요.



사이드톤 조절

사이드톤 기능은 통화 중 자신의 목소리를 들을 수 있게 해줌으로써 자신이 얼마나 큰 소리로 말하고 있는지를 인식하게 해줍니다. Logi Tune 앱에서 사이드톤 기능을 선택한 후 헤드셋을 착용하고 말하면서 설정을 조정합니다.

- 숫자가 높을수록 외부 소리가 더 크게 들립니다.
- 숫자가 낮을수록 외부 소리가 더 작게 들립니다.

마이크 EQ

Logi Tune의 마이크 EQ를 사용자 지정하여 목소리가 더 밝거나 깊게 들리도록 조절할 수 있습니다.

청력 보호

Zone Wired 2 for Business는 안전한 청취를 위해 세 가지 유형의 보호 기능을 제공합니다.

피크 제한: 청력 손상을 방지하기 위해 오디오 볼륨은 항상 100dBA로 제한됩니다.

음향 충격에 대한 보호: 오스트레일리아 G616 지침에 따라 갑작스러운 오디오 스파이크를 제거하여 음향 충격을 방지합니다. 이는 Logi Tune 앱에서 활성화할 수 있으며 통화 활동에만 적용됩니다.

시간 경과에 따른 소음 노출: 오스트레일리아 G616 지침에 따라 통화 시 일일 평균 수준이 시간 가중 평균 85dBA를 초과하지 않도록 모니터링합니다. 이는 Logi Tune 앱에서 활성화할 수 있으며 통화 활동에만 적용됩니다.

통화용 EQ 활성화

이제 Logi Tune에서 음악뿐만 아니라 통화에도 이퀄라이저 설정을 적용할 수 있습니다. 통화 중에 들리는 사운드를 보다 깊은 저음, 보다 선명한 고음 또는 그 외 선호하는 설정으로 맞춤 조정할 수 있습니다.

Logi Tune에서 "통화에 EQ 활성화" 토글을 켜면 통화에서 커스터마이징한 이퀄라이저 설정을 사용할 수 있습니다.

절전 모드

Logi Tune의 절전 모드를 활성화하면 헤드셋이 연결된 장치의 전력 소비를 줄일 수 있습니다.

활성화 상태에서 30분 동안 아무런 작업이 없으면 헤드셋은 전력 절약을 위해 자동으로 액티브 노이즈 캔슬링(ANC)과 표시등을 끕니다.

통화에 참여하거나, 음악을 듣거나, 아무 버튼이나 누르면 헤드셋의 절전 모드가 해제됩니다.

헤드셋 업데이트

헤드셋을 업데이트하여 최적의 성능을 유지하는 것을 권장합니다.

업데이트하려면, logitech.com/tune에서 Logi Tune을 다운로드하고 사용 가능한 펌웨어 업데이트를 확인합니다.

치수

헤드셋:

높이 x 너비 x 높이:
185.2 x 183.6 x 73.0mm

무게:

223.5g

어댑터:

높이 x 너비 x 높이:
24.5 x 15.4 x 8.7mm

시스템 요구 사항

대부분의 플랫폼 및 운영 체제에서 일반적으로 사용되는 통화 애플리케이션을 지원합니다.
USB-C 또는 USB-A를 통해 *Windows*, *Mac* 혹은 *Chrome*기반 컴퓨터³에서 사용할 수 있습니다.

기술 사양

마이크 유형: AI 기반 알고리즘과 마이크 EQ가 적용된 2개의 노이즈 캔슬링 마이크

주파수 응답(헤드셋): 20Hz~20 kHz(음악 모드), 100Hz~8kHz(대화 모드)

주파수 응답(마이크): 100Hz~8kHz

케이블 길이: 1.9 m

오디오 규정 준수: EN 50332-2 규격

각주

- ¹ Logi Tune에서 버튼을 커스터마이징 할 수 있습니다. logitech.com/tune에서 Logi Tune 호환성을 확인해 보세요.
- ² 이 헤드셋은 현재 Logi Tune 데스크탑 앱에서 다음 언어에 대한 음성 명령어를 지원합니다. 영어, 프랑스어, 독일어, 스페인어. 앱에서 선호하는 언어를 선택할 수 있습니다.
- ³ 장치 기본 기능은 Logi Tune을 지원하지 않는 운영 체제에서도 사용할 수 있습니다.

www.logitech.com/support/zonewired2b

© 2025 Logitech. Logitech, Logi, Zone, and the Logitech logo are trademarks or registered trademarks of Logitech Europe S.A. and/or its affiliates in the U.S. and other countries. *Windows* is a trademark of the Microsoft group of companies. *macOS* is a trademark of Apple Inc. *Google*, *ChromeOS*, and *Chrome* are trademarks of Google LLC. *USB-C* is a trademark of USB Implementers Forum. All other third party trademarks are the property of their respective owners. Logitech assumes no responsibility for any errors that may appear in this manual. Information contained herein is subject to change without notice.

© 2025 Logitech. Logitech, Logi, Zone et le logo Logitech sont des marques commerciales ou déposées de Logitech Europe S.A. et/ou de ses sociétés affiliées aux États-Unis et dans d'autres pays. *Windows* est une marque déposée du groupe de sociétés Microsoft. *macOS* est une marque déposée d'Apple Inc. *Google*, *ChromeOS* et *Chrome* sont des marques commerciales de Google LLC. *USB-C* est une marque déposée d'USB Implementers Forum. Toutes les autres marques déposées tierces sont la propriété de leurs détenteurs respectifs. Logitech décline toute responsabilité en cas d'erreurs susceptibles de s'être glissées dans le présent manuel. Les informations énoncées dans ce document peuvent faire l'objet de modifications sans préavis.