

# LOINC Document Ontology: Ontario Use Case

Connecting Ontario Terminology

DIGITAL HEALTH STANDARDS | SEPTEMBER 22, 2025

# Background

- The **Acute and Community Clinical Data Repository (acCDR)** is a key component of the ConnectingOntario solution architecture
- Data comes from contributing hospitals and home and community care support services across the province to inform the patient electronic health record
- It supports patients by providing care teams with a central point of access to an up-to-date, integrated care record
- Ontario's Provincial Clinical Viewers, ConnectingOntario and ClinicalConnect, are used to view acute clinical information contained in the Acute and Community Clinical Data Repository (acCDR)

# Scope of Data

- The Clinical Data Repository aims to include any document that would be clinically relevant to a clinician who is subsequently treating the patient at another institution and that can be submitted in an HL7 message that conforms to the acCDR Input Standard
- Data contributed includes Admission, Discharge and Transfer (ADT) information as well as all clinical documents and results related to a patient
- Some examples of priority data types are emergency department reports, consultation and evaluation reports, discharge summaries, cardiovascular reports, mental health reports, surgical reports

# ConnectingOntario Terminology

- Documents sent to the acCDR using their local document type code from their information system are mapped to the provincial terminology code
- ConnectingOntario Terminology uses LOINC and its document ontology axes to describe the documents and results

Seq	Use	Opt	Len	DT	Vocab Tbl#	Field Description	Sample Data_(Notes)
CNE.1	All	R	60	ST		Identifier	<i>DSUM (HIC Defined)</i> 1. Please provide local code for hospital report type 2. If possible, a LOINC or ConnectingOntario-C code should also be included in CE.4 3. For HRM only - The combined length of OBR-4.1 and OBR-4.2 cannot exceed 59
CNE.2	All	R	200	ST		Text	Discharge Summary <i>(HIC Defined)</i>
CNE.3	All	R	50	ID	9007	Name of Coding System	1.3.6.1.4.1.12201.2.1 <i>(acCDR Provided)</i>
CNE.4	All	RE	60	ST		LOINC or ConnectingOntario C-Code	LOINC Code or C-code from the ConnectingOntario Terminology corresponding to the local code provided CNE.1 Example:18842-5
CNE.5	All	RE	200	ST		Text description for CNE.4	Discharge Summary

# ConnectingOntario Document Ontology

- ConnectingOntario codes are linked to five Document Ontology Axes, which are used to categorize documents for ClinicalViewer display and filtering
- This metadata allows the solution to perform queries for certain “groups” of documents using a document categorization concept, without the front end needing to know the various local codes used in the Hospital Information System (HIS)

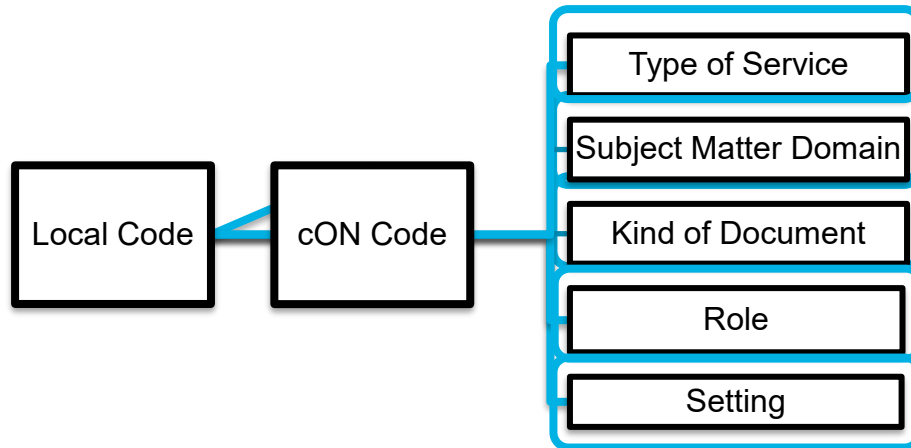



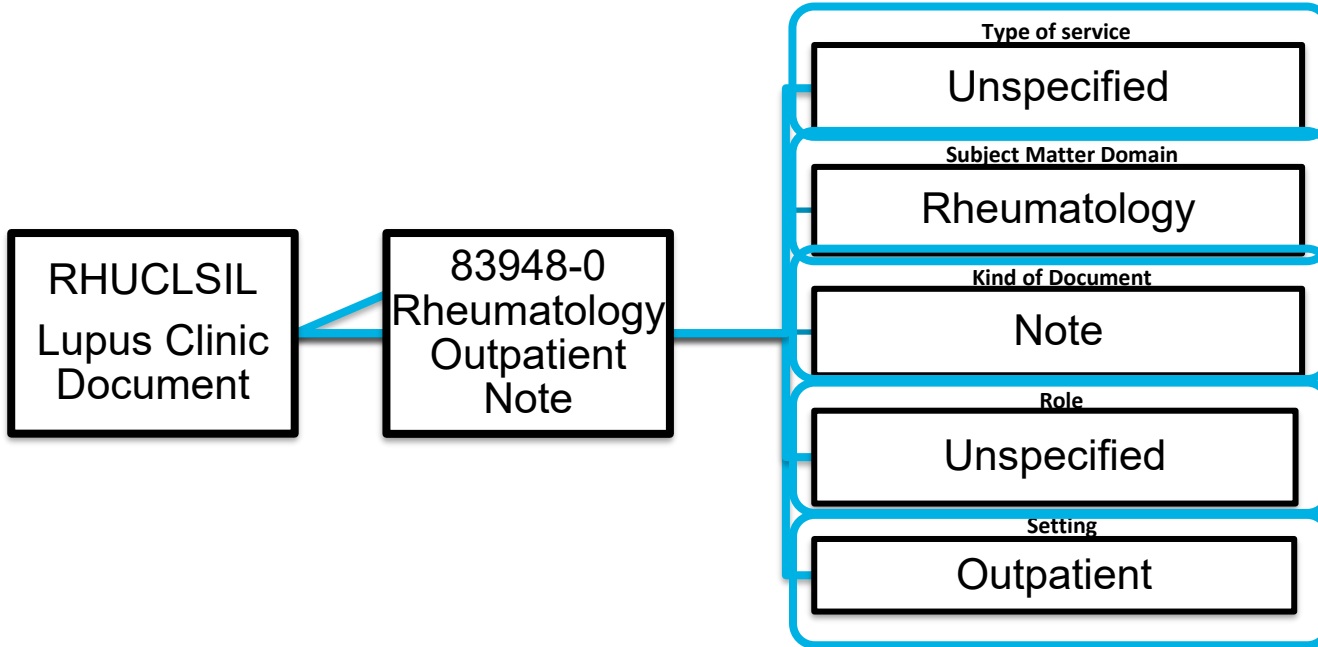





















# Terminology Mapping Example



# ConnectingOntario ClinicalViewer

Information found within the clinical data repositories

Acute and Community Care Clinical Data		
 Allergy information*	 DI reports	 Mental health assessments & reports
 Cardiovascular reports	 Discharge summaries	 Neurophysiology reports
 Consent directives & override rules	 ED Reports	 Respiratory reports
 Consultation reports	 Infection control information	 Surgical reports
 Demographics	 Medication profile*	 Visit/encounter details
 Community care information (long-term care home details, service details, client risk & assessments, coordinated care plans)		
Diagnostic Imaging	Laboratory Results	Medication Information
 Images  Reports For the following modalities: <ul style="list-style-type: none"> <li>• X-ray</li> <li>• Computerized tomography (CT) scan</li> <li>• Magnetic resonance imaging (MRI)</li> <li>• Ultrasound</li> <li>• Mammography</li> <li>• Angiography</li> <li>• Fluoroscopy</li> <li>• Positron emission tomography (PET) scan</li> <li>• Nuclear medicine</li> <li>• Bone mineral density</li> </ul>	 Biochemistry  Blood bank  Hematology  Microbiology  Pathology	 Ontario Drug Benefit (ODB)  Narcotics Monitoring System (NMS)

# ConnectingOntario ClinicalViewer

ConnectingOntario  
**ClinicalViewer** The ConnectingOntario Portal may not contain all clinical information for an individual. Click the Data Summary link for details.

Search for a patient | Welcome: 32 cGTATRAINING (University Health Network) | Logout

**My Workspace** | **Patient Care**

**ZALESKI, Mabele** | DOB: 12 Aug 1940 (79y) Male | HCN: 3121530152  
Contact & Address: 29412 Earle Shores St, Freshwater, ON A7E 2N8

**Timeline**  
Time Interval: 7D 30D 3M 6M 1Y Custom | Displaying 11 Sep 2019 to 29 Sep 2011 | View Refreshed: 11:40 AM

**Medications**  
Dispensed Medications  
**Warning: Limited to drug information and pharmacy services available in DHDR.**

Dispensed Date	Generic Name	Brand Name	Strength	Form
16 May 2014	INSULIN HUMAN BIOSYNTH...	Humulin 30/70	1000U/10mL	INJ SUSP-10
16 May 2014	BISOPROLOL FUMARATE	Novo-Bisoprolol	5mg	ORAL/TAB
16 May 2014	MedsCheck LTC Annual	Meds Check		
16 May 2014	CIPROFLOXACIN	Apo-Ciproflo	500mg	ORAL/TABLE
16 May 2014	ACETYLSALICYLIC ACID	Novasyn	325mg	ORAL/ENT T.
16 May 2014	PERINDOPRIL ERBUMINE	Covaryl	2mg	ORAL/TAB
16 May 2014	ROSUVASTATIN CALCIUM	Ran-Rosuvastatin	20mg	ORAL/TAB

30 results returned from system

**Documents/Notes**  
View

Document Date/Time	Document	Description
15 May 2014 00:00		Ambulatory Consult
10 Jan 2014 15:33		Discharge Summary
13 Dec 2013 15:33		OR Procedure/Note
05 Oct 2013 00:00		ED RECORD
05 Oct 2013 00:00		WOUND CARE

5 results returned from system

**Lab and Pathology Results**  
Click the button on the right to view blocked PHI | Override Consent

Collection Date/Time	Last Updated	Ordered As	Test	Flag
15 May 2014 00:10	09 Sep 2014 16:13	Glucose Fasting	Glucose Fasting	HH
15 May 2014 00:10	09 Sep 2014 16:13	Hemoglobin A1 C	Hemoglobin A1C/Total He...	
15 May 2014 00:10	09 Sep 2014 16:13	Electrolytes	Potassium	H
15 May 2014 00:10	09 Sep 2014 16:13	Electrolytes	Potassium	HH
15 May 2014 00:10	09 Sep 2014 16:13	Electrolytes	Chloride	
15 May 2014 00:10	09 Sep 2014 16:13	Lipid Panel	Cholesterol	
15 May 2014 00:10	09 Sep 2014 16:13	Lipid Panel	Cholesterol/Cholesterol In ...	

550 results returned from system

**Visits/Encounters and Summary Reports**  
View

Date	Type	Summary Reports	Organization
16 Aug 2016	Ambulatory		Health Sciences North
07 Feb 2016	Ambulatory		UHN - Toronto General Hospital
15 Jun 2015	Ambulatory		UHN - Toronto Western Hospital
15 May 2014	Ambulatory		UHN - Toronto General Hospital
10 Dec 2013	Inpatient		UHN - Toronto General Hospital
05 Oct 2013	ED		UHN - Toronto General Hospital

6 results returned from system

**Community**  
View

Referral Start Date	Referral Type	Reason for Referral	Service Details
18 Feb 2014	Long Term Placement	Accident Trauma	
18 Feb 2014	Long Term Placement	Accident Trauma	

# Document Ontology - Type of Service

- Characterizes the kind of healthcare service or activity provided to/for the patient (or other subject of the service) as described in the document.
- Common service types include:
  - Evaluations
  - Consultations
  - Summaries
    - » Discharge Summary
    - » Transfer Summary
  - History & Physical
  - Plan of care

# Document Ontology - Subject Matter Domain

- Characterizes the general focus or domain of knowledge represented within the content of the document. Usually abstracted from specialties defined in American Board Specialties or Royal College of Physicians & Surgeons Specialties.
- Common subject matter include:
  - Pediatrics
  - Cardiology
  - Dermatology
  - Emergency Medicine
  - Nephrology
  - Orthopedic Surgery

# Document Ontology - Kind of Document

- Characterizes the general structure of the document at a macro level.
- Common examples:
  - Report
  - Form
  - Flowsheet
  - Letter
  - Note
  - Instructions

# Document Ontology - Role

- Characterizes the general function, responsibility, or capabilities of the author in relation to a document.
- Common roles are:
  - Case manager
  - Healthcare navigator
  - Nurse / Nurse practitioner
  - Physician
  - Rapid response team
  - Social worker

# Document Ontology - Setting

- Describes the clinical environment where the care was delivered.
- Example settings:
  - Emergency Department
  - Outpatient
  - Hospital
  - Telehealth
  - Telephone encounter
  - Telehealth Outpatient

# ConnectingOntario Terminology

- There are over 1700 LOINC codes incorporated into the provincial set, and about 100 ConnectingOntario codes
  - All adopted LOINC codes have been assigned document ontology axes, even if the LOINC code does not have classtype: DOC.ONTOLOGY
  - There are a small number of cases where we have adopted the LOINC code but retained our own display name as requested in the request for change. Examples:
    - Respiriology vs Pulmonary
    - Cardiac ECG study vs EKG study
    - Medical assistance in dying (MAID) vs Medical aid in dying

# Connecting Ontario Terminology

- There are about 100 C-codes created for proprietary use
  - About 70 of these proprietary codes are new codes created for Ontario use case which are currently in use by implementers, with a pending request for change with Regenstrief
  - 20 C-codes are local extensions created for Ontario use case (ie. Home and community care support services documents, generic medical imaging report types)
  - The remaining are currently in review for deprecation or alignment with LOINC LCN and/or axes

# Diagnostic Study Report Types

- All diagnostic study report types have been assigned LOINC part LP173115-9 Diagnostic study for Type of Service and LP173421-1 Report for Kind of Document, in order to filter these reports to the appropriate viewer in the current ConnectingOntario solution.
  - This may change as Ontario Health is undergoing modernization activities in how EHR assets integrate with one another
- Each of the diagnostic study reports have been assigned a Subject Matter Domain that exists in LOINC to optimize query results and report categorization
  - Cardiology diagnostic study reports have been assigned CGTA1002-1 Cardiology for Subject Matter Domain as LOINC SMD 'Cardiovascular disease' is not optimal for search

# Editorial Guidelines - Examples

Terms	Map As (LOINC)
Advance directive/Living will/Goals of care	Patient Personal advance care plan - Advanced directives and living wills are used in common language in Ontario, however, these terms should not be used as "there is no reference in the Health Care Consent Act or Substitute Decisions Act to "Advance Directives" or "Living wills", and the use of these terms causes confusion. These terms are names of documents described in law in other jurisdictions (ie. other provinces, United States). Out-of-province documents that use Advance directives may be mapped to 42348-3 Advance directives, even though they are not legal in Ontario. Reference: <a href="https://www.speakupontario.ca/resource-guide/part-3-advanced-care-planning/">https://www.speakupontario.ca/resource-guide/part-3-advanced-care-planning/</a>
Behaviour Therapy/Applied Behavioral Analysis (ABA)	Psychology
Gerontology	Geriatric Medicine

# Editorial Guidelines - Examples

Terms	Map As (LOINC)
Heart function	Heart failure
Nutrition / Dietician	Nutrition and Dietetics
Pharmacy	Pharmacology
Rehabilitation Medicine	Physical Medicine and Rehab
Respirology	Pulmonology with SMD Pulmonary Disease
Stroke	Vascular neurology
Thoracic Surgery	Cardiothoracic Surgery
Virtual Visits/Virtual Care	Telehealth
WSIB	Workers compensation



# Connecting Ontario Terminology

AutoSave On Sample\_TerminologyMapping\_Worksheet\_20250417Exe... Saved Search

File Home Insert Draw Page Layout Formulas Data Review View Automate Help

Calibri 11 General Conditional Formatting Insert Delete Format Sensitivity

B11

	A	B	C	D	E	F	G	H	I	J	K	L	M
	cON Cod	cON Display Name	Type of Service	Kind of Service	Comment	Subject	Ter Domain	Role	Setting				Displays in ConnectingOntario Viewer Portlet
1	87252-3	Addition medicine Admission evaluation note	LP173205-8	Admission evaluation	LP173418-7	Note	LP283512-8	Addition medicine	CGTA4001-1	Unspecified	CGTA5001-1	Unspecified	Documents/Notes and InPatient Visit Summary
2	87254-9	Addition medicine Consult note	LP173110-0	Consultation	LP173418-7	Note	LP283512-8	Addition medicine	CGTA4001-1	Unspecified	CGTA5001-1	Unspecified	Documents/Notes
3	87255-6	Addition medicine Counseling note	LP173100-1	Counseling	LP173418-7	Note	LP283512-8	Addition medicine	CGTA4001-1	Unspecified	CGTA5001-1	Unspecified	Documents/Notes
4	87256-4	Addition medicine Discharge summary	LP173221-5	Discharge summary	LP173418-7	Note	LP283512-8	Addition medicine	CGTA4001-1	Unspecified	CGTA5001-1	Unspecified	Documents/Notes and InPatient Visit Summary
5	87259-8	Addition medicine History and physical note	LP173196-5	History and physical	LP173418-7	Note	LP283512-8	Addition medicine	CGTA4001-1	Unspecified	CGTA5001-1	Unspecified	Documents/Notes
6	87260-6	Addition medicine Initial evaluation note	LP173204-1	Initial Assessment	LP173418-7	Note	LP283512-8	Addition medicine	CGTA4001-1	Unspecified	CGTA5001-1	Unspecified	Documents/Notes
7	87249-9	Addition medicine Outpatient Note	CGTA2019-1	Unspecified	LP173418-7	Note	LP283512-8	Addition medicine	CGTA4001-1	Unspecified	LP173051-6	Outpatient	Documents/Notes
8	93892-8	Addition medicine Progress note	LP173213-2	Progress	LP173418-7	Note	LP283512-8	Addition medicine	CGTA4001-1	Unspecified	CGTA5001-1	Unspecified	Documents/Notes
9	68611-3	Adolescent medicine Diagnostic study note	LP173115-9	Diagnostic study	LP173421-1	Report	LP172913-8	Adolescent medicine	CGTA4001-1	Unspecified	CGTA5001-1	Unspecified	Other Results
10	68612-1	Adolescent medicine Discharge summary	LP173221-5	Discharge summary	LP173418-7	Note	LP172913-8	Adolescent medicine	CGTA4001-1	Unspecified	CGTA5001-1	Unspecified	Documents/Notes
11	68614-7	Adolescent medicine History and physical note	LP173196-5	History and physical	LP173418-7	Note	LP172913-8	Adolescent medicine	CGTA4001-1	Unspecified	CGTA5001-1	Unspecified	Documents/Notes
12	68619-6	Adolescent medicine Hospital Consult note	LP173110-0	Consultation	LP173418-7	Note	LP172913-8	Adolescent medicine	CGTA4001-1	Unspecified	LP173065-6	Hospital	Documents/Notes
13	68620-4	Adolescent medicine Hospital Letter	CGTA2019-1	Unspecified	LP173417-9	Letter	LP172913-8	Adolescent medicine	CGTA4001-1	Unspecified	LP173065-6	Hospital	Documents/Notes
14	68615-4	Adolescent medicine Note	CGTA2019-1	Unspecified	LP173418-7	Note	LP172913-8	Adolescent medicine	CGTA4001-1	Unspecified	CGTA5001-1	Unspecified	Documents/Notes
15	68616-2	Adolescent medicine Preoperative evaluation and management note	LP173216-5	Preoperative evaluation and management	LP173418-7	Note	LP172913-8	Adolescent medicine	CGTA4001-1	Unspecified	CGTA5001-1	Unspecified	Documents/Notes
16	68617-0	Adolescent medicine Progress note	LP173213-2	Progress	LP173418-7	Note	LP172913-8	Adolescent medicine	CGTA4001-1	Unspecified	CGTA5001-1	Unspecified	Documents/Notes
17	68618-8	Adolescent medicine Transfer summary note	LP173226-4	Transfer summary	LP173418-7	Note	LP172913-8	Adolescent medicine	CGTA4001-1	Unspecified	CGTA5001-1	Unspecified	Documents/Notes
18	101038-8	Aerospace medicine Consult note	LP173110-0	Consultation	LP173418-7	Note	LP172915-3	Aerospace medicine	CGTA4001-1	Unspecified	CGTA5001-1	Unspecified	Documents/Notes
19	85587-4	Aerospace medicine Note	CGTA2019-1	Unspecified	LP173418-7	Note	LP172915-3	Aerospace medicine	CGTA4001-1	Unspecified	CGTA5001-1	Unspecified	Documents/Notes
20	101041-2	Aerospace medicine Procedure note	LP173234-8	Procedure	LP173418-7	Note	LP172915-3	Aerospace medicine	CGTA4001-1	Unspecified	CGTA5001-1	Unspecified	Documents/Notes
21	101039-6	Aerospace medicine Progress note	LP173213-2	Progress	LP173418-7	Note	LP172915-3	Aerospace medicine	CGTA4001-1	Unspecified	CGTA5001-1	Unspecified	Documents/Notes
22	95761-3	Allergy Consult note	LP173110-0	Consultation	LP173418-7	Note	LP345051-9	Allergy	CGTA4001-1	Unspecified	CGTA5001-1	Unspecified	Documents/Notes
23	95762-1	Allergy Diagnostic study note	LP173115-9	Diagnostic study	LP173421-1	Report	LP345051-9	Allergy	CGTA4001-1	Unspecified	CGTA5001-1	Unspecified	Other Results
24	95760-5	Allergy Education note	LP173117-5	Education	LP173418-7	Note	LP345051-9	Allergy	CGTA4001-1	Unspecified	CGTA5001-1	Unspecified	Documents/Notes
25	95763-9	Allergy Evaluation note	LP173124-1	Assessment	LP173418-7	Note	LP345051-9	Allergy	CGTA4001-1	Unspecified	CGTA5001-1	Unspecified	Documents/Notes and InPatient Visit Summary
26	95758-9	Allergy Flowsheet	CGTA2019-1	Unspecified	LP173415-3	Flowsheet	LP345051-9	Allergy	CGTA4001-1	Unspecified	CGTA5001-1	Unspecified	Documents/Notes
27	95755-5	Allergy Initial evaluation note	LP173204-1	Initial Assessment	LP173418-7	Note	LP345051-9	Allergy	CGTA4001-1	Unspecified	CGTA5001-1	Unspecified	Documents/Notes and InPatient Visit Summary
28	95759-7	Allergy Plan of care note	LP173209-0	Plan of care	LP173418-7	Note	LP345051-9	Allergy	CGTA4001-1	Unspecified	CGTA5001-1	Unspecified	Documents/Notes
29	95756-3	Allergy Procedure note	LP173234-8	Procedure	LP173418-7	Note	LP345051-9	Allergy	CGTA4001-1	Unspecified	CGTA5001-1	Unspecified	Documents/Notes
30	95757-1	Allergy Progress note	LP173213-2	Progress	LP173418-7	Note	LP345051-9	Allergy	CGTA4001-1	Unspecified	CGTA5001-1	Unspecified	Documents/Notes
31	95754-8	Allergy Referral note	LP173238-9	Referral	LP173418-7	Note	LP345051-9	Allergy	CGTA4001-1	Unspecified	CGTA5001-1	Unspecified	Documents/Notes
32	77429-9	Allergy and Immunology Consult note	LP173110-0	Consultation	LP173418-7	Note	LP345051-9	Allergy	CGTA4001-1	Unspecified	CGTA5001-1	Unspecified	Documents/Notes
33	68626-1	Allergy and Immunology Discharge summary	LP173221-5	Discharge summary	LP173418-7	Note	LP345043-6	Immunology	CGTA4001-1	Unspecified	CGTA5001-1	Unspecified	Documents/Notes and InPatient Visit Summary
34	77434-9	Allergy and Immunology Evaluation note	LP173124-1	Assessment	LP173418-7	Note	LP345051-9	Allergy	CGTA4001-1	Unspecified	CGTA5001-1	Unspecified	Documents/Notes and InPatient Visit Summary
35							LP345043-6	Immunology	CGTA4001-1	Unspecified	CGTA5001-1	Unspecified	Documents/Notes and InPatient Visit Summary
							LP345051-9	Allergy	CGTA4001-1	Unspecified	CGTA5001-1	Unspecified	Documents/Notes

Site Map Diagnostic Reports Guidance DICS Integration cON Terminology v07-20250305 Edit +



# Questions?